

# PR-C201

## Operation Guide

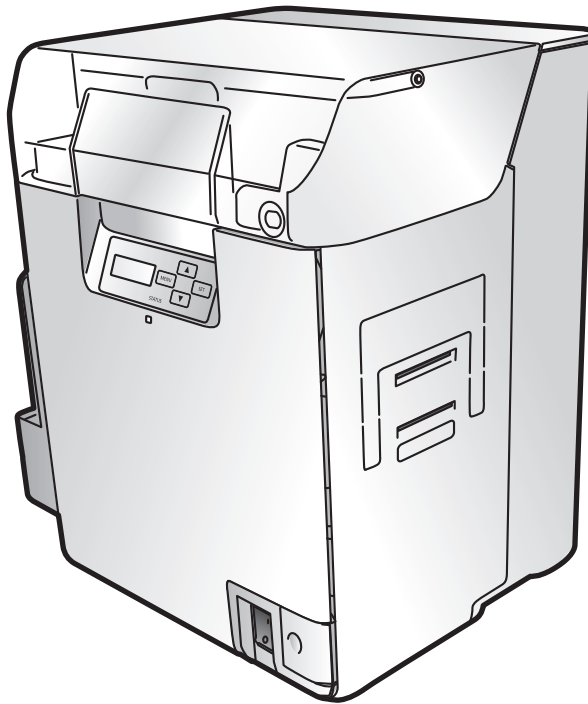

**nisca**

## Features of the card printer PR-C201

### Easy Card Loading

---

Thanks to the Multifunctional Card Case, it is possible to feed cards without detaching the Card Case. (→ p10)

### Strengthened Security

---

- You can anchor the printer with a cable using the Security Cable Slot. (→ p53)
- It is easy to store cards in the removable Card Case. (→ p53)

### Easy Operation

---

Use of Ink Ribbon/Transfer Film Cassettes makes it easy for anyone to change ribbons and films. (→ p16)

### Easy Setup

---

The printer comes with a printer driver CD, so if you also have the Ink Ribbon, Transfer Film, and cards (available separately), you can use the printer immediately after setup. (→ Easy Setup Guide)

## About Symbols



### WARNING

These are warnings indicating the risk of accidents, fire, or electric shock if the printer is not operated correctly. Be sure to follow these warnings to operate the printer safely.



### CAUTION

These cautions indicate the risk of injury or malfunction if the printer is not operated correctly. Be sure to follow these cautions to operate the printer safely.



### Important

These offer important advice you should follow when operating the printer. Be sure to read this advice to prevent malfunctions or damage to the printer.



### Note

These are notes with helpful or additional information about using the printer.



### REF

These are references that make the manual easier to use.

- Windows is registered trademarks or trademarks of Microsoft Corporation in the U.S. and / or other countries.

## Contents

<b>Operating the Printer Safely .....</b>	<b>1</b>
Regulations for this product FCC Regulations .....	3
<b>Part Names and Descriptions.....</b>	<b>4</b>
Front Side of the Printer .....	4
Inside the Top Cover .....	5
Rear Side of the Printer .....	6
Front Cover .....	7
Operation Panel .....	8
<b>Basic Card Printing Methods .....</b>	<b>9</b>
Turning On and Off the Printer .....	9
Loading Cards.....	10
Loading Cards into the Card Case .....	10
Manually Loading Cards One by One .....	12
Loading Magnetic/IC Cards.....	13
Printing.....	14
Removing Cards .....	15
Changing the Ink Ribbon and Transfer Film.....	16
Checking Replacement Period, and Preparation .....	16
Changing the Ink Ribbon.....	17
Transfer Film Replacement .....	19
Cleaning Tape Replacement.....	22
<b>Normal Mode and User Mode .....</b>	<b>23</b>
Normal Mode and User Mode.....	23
Normal Mode .....	23
User Mode .....	24
Switching to User Mode .....	24
Basic User Mode Operations .....	25
Moving to the Next Menu (Switching to Menus on the Same Level) .....	25
Moving to a Sub-menu (Switching to Menus on a Lower Level).....	25
Returning to the Main Menu (Switching to Menus on a Higher Level) .....	26
Switching to Normal Mode (Exiting User Mode).....	26
<b>Printer Settings.....</b>	<b>27</b>
Counting the Number of Cards that Are Printed .....	27
Displaying the Total Number of Sides that Are Printed .....	28
Checking the type and remaining quantity of the Ink Ribbon or Transfer Film .....	29
Checking the Program Version and Serial Number .....	30
Turning the Error Alarm On or Off.....	31
Reduce Printer Power Consumption.....	32
Adjusting the Print Results.....	33
Adjusting the printing position .....	33
Quality printing/Quick printing .....	35
Correcting image and text misalignment.....	36

## Full Color Card Printer

Adjusting the contour level .....	37
Adjusting the hue .....	38
Setting the Type of Ink Ribbon or Transfer Film to Use .....	39
Notification of Time for Ink Ribbon and Transfer Film Replacement .....	41
Setting the Types of Card to Use .....	42
Adjusting the Feed Gate Depending on Card Thickness .....	42
Optimizing Transfer Conditions .....	43
Correcting Card Curl .....	45
Switching the Card Ejection Slot .....	46
Set the Orientation of Magnetic Cards/IC Cards to Load .....	47
Set the Orientation of Cards to Eject .....	49
Changing Network Connection Settings .....	51
Preventing Theft and Unauthorized Usage .....	53
Preventing Theft of the Printer (Security Cable Slot) .....	53
How to Store Cards (Removing the Card Case) .....	53
<b>Cleaning .....</b>	<b>54</b>
Before Cleaning .....	54
Cleaning with a Cleaning Card .....	54
Cleaning the Cleaning Roller .....	57
Cleaning the Feeding Roller .....	59
Cleaning the Feeding Roller .....	60
Cleaning the Reverse Roller .....	62
Primary Transfer Feeding Roller Cleaning .....	64
Filter Cleaning .....	66
<b>Troubleshooting .....</b>	<b>67</b>
When an Error Message Appears .....	67
Clearing an Error .....	67
How to Clear an Error .....	67
When a Card is Jammed .....	73
If the Ink Ribbon or Transfer Film are Cut .....	76
When Cards are Not Printed Correctly .....	78
Other Troubles .....	80
When These Solutions Don't Work .....	80
<b>Appendix .....</b>	<b>81</b>
Consumables .....	81
Ink Ribbon/Transfer Film .....	81
Cards .....	82
Cleaning Card .....	82
Cleaning Tape .....	82
Consumables .....	82
Updating the Printer's Software .....	83
Menu Route Map (User Mode) .....	84
Main Specifications .....	86
Opening the Printer Driver Settings Screen .....	87
Opening the Setting Screen (From the Start Menu) .....	87
Opening the Setting Screen (From the Application) .....	87
Changing the Settings or Confirming the Status from the Setting Screen .....	87

# Operating the Printer Safely

The following precautions must be observed to assure safe operation of the printer. Also, do not do anything that is not described in this manual. Doing so may cause an unexpected accident.

**⚠ WARNING** Failure to observe the following items while using the printer may cause fire, electric shock or other unexpected accident.

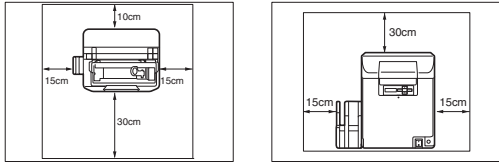
Installation location	Do not install the printer in a damp or dusty location.
	Do not install the printer near flammable or explosive materials or heater, stove or other device that produces heat.
	Place the printer away from walls, as shown in the diagram below, to maintain air flow. Also, maintain at least 30 cm of open space above the printer. Blocking the vents may cause the printer to overheat and catch fire.
	 <p>The left illustration indicates distance values when the Card Stacker is attached.</p>
Power supply	Use a dedicated power cable and do not use an extension cord with multiple outlets.
	Be sure to remove any dust from the plug and outlet. Humidity produces a micro-current on the surface causing overheating or fire.
	Do not damage or modify the Power Cable. Also, do not place heavy objects, pull, or bend excessively.
	Do not plug in or unplug the Power Cable if your hands are wet.
	Ensure a ground wire is connected. When connecting the ground wire, note the following cautions.
	<ul style="list-style-type: none"> <li>• Recommended connections for ground wires <ul style="list-style-type: none"> <li>Outlet ground terminal</li> <li>Ground terminals installed as type A, B, or C</li> <li>A copper rod 65 cm or longer buried in the ground.</li> </ul> </li> <li>• Not permitted for ground wires <ul style="list-style-type: none"> <li>Gas piping (risk of fire or explosion.)</li> <li>Water pipes or taps (water pipes that include plastic piping cannot act as a ground. However, if a water pipe is configured to act as a ground, then connection of a ground wire is permitted.)</li> <li>Telephone line ground wires or lightning conductors (danger of high current flow in the event of a lightening strike.)</li> </ul> </li> </ul>
Be sure to turn off the power and unplug the plug from the outlet before moving the printer.	
Pull on the plug, not the cable, when unplugging it from an outlet.	
Handling	Do not use flammable sprays near the printer.
	Do not touch anything inside the printer unless specified in this manual.

**Full Color Card Printer**

**! WARNING**

The lower part of the Top Cover, the printer internal heat roller section, and the thermal head section get very hot. Ensure you do not touch these three locations.

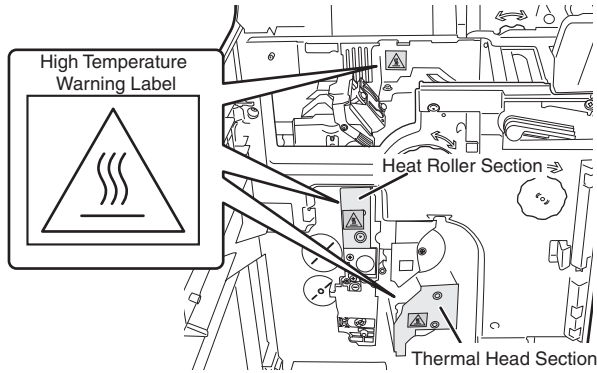

**! CAUTION** Failure to observe the following items while using the printer may cause injury or a malfunction.

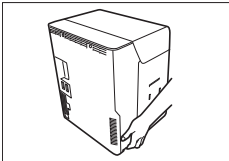
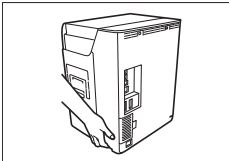
Installation location	Do not install the printer on an unstable table, on a slant, or any place where there is excessive vibration.
	Do not install the printer in a location susceptible to rapid fluctuations in temperature.
	Do not install the printer in a location exposed to direct sunlight.
Power supply	Do not use an under-rated extension cord.
Handling	Do not place heavy items on the printer and do not lean on the printer.
	When moving the printer, carry it as shown below. <div style="display: flex; justify-content: space-around; align-items: center;">   </div>
While the printer is operating, do not turn off the power, unplug the power cable, or look inside the printer.	

- The cooling fan is always running for cooling the inside of the printer. This is not a malfunction.
- Contact your reseller if there is a current leak.
- The printer may cause static, flickering or interrupt reception of televisions or radios if they are too close to the printer.

**! CAUTION** Regarding copyrights  
 Using portraits (photos or images) or copyrighted material (illustrations or logos) without the permission of their owners is prohibited by law.  
 Do not use copyrighted images without permission or for illegal activities.

- CAUTION** Under the following conditions images on cards may deteriorate or cards may warp after printing.
- The surface of the card is in contact for an extended period of time with a vinyl card holder or synthetic leather or other material that contains plasticizer.
  - The surface of the card is exposed to direct sunlight for an extended period of time.
  - The card is repeatedly rubbed against a hard object.
  - The faces of two cards are in contact for an extended period of time.
  - The card is kept for an extended period of time in a very hot location such as a car parked in the sun.
  - The card is bent, or used with excessive force.

If a card with a magnetic strip is placed near a magnetic source, the data on the strip may become corrupted.

Additionally, if the IC card is bent, or used with excessive force, the IC chip may be damaged.

## Regulations for this product FCC Regulations

This device complies with Part 15 of the FCC Rules. Operation is subject to the following two conditions: (1) This device may not cause harmful interference, and (2) this device must accept any interference received, including interference that may cause undesired operation.

### Note

This equipment has been tested and found to comply with the limits for class B digital device, pursuant to Part 15 of the FCC Rules. These limits are designed to provide reasonable protection against harmful interference in a residential installation. This equipment generates uses and can radiate radio frequency energy and, if not installed and used in accordance with the instructions, may cause harmful interference to radio communications. However, there is no guarantee that interference will not occur in a particular installation. If this equipment does cause harmful interference to radio or television reception, which can be determined by turning the equipment off and on, the user is encouraged to try correct the interference by one or more of the following measures:

- Reorient or relocate the receiving antenna.
- Increase the separation between the equipment and receiver.
- Connect the equipment into an outlet on a circuit different from that to which the receiver is connected.
- Consult the dealer or an experienced radio/TV technician for help.

Do not make any changes or modifications to the equipment unless otherwise specified in the manual.

If such changes or modifications should be made, you could be required to stop operation of the equipment.

# Part Names and Descriptions

## Front Side of the Printer

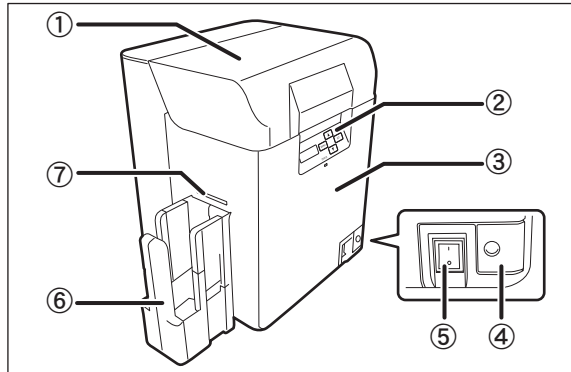

**① Top Cover**

Open when loading cards or cleaning the feeding roller.

**② Operation Panel**

Includes the keys, the LCD Panel, and LED indicator for operating the printer.

→See "Operation Panel" on page 8 for detailed Operation Panel part names and descriptions.

**③ Front Cover**

Open when changing ink ribbons and transfer film, and when cleaning the Cleaning Roller.

→See "Front Cover" on page 7 for information about the names of parts inside the cover and their descriptions.

→See "Changing the Ink Ribbon and Transfer Film" on page 16 for details about changing the Ink Ribbon Cartridge.

→See "Cleaning" on page 54 for instructions on cleaning the Cleaning Roller.

**④ Open Cover Switch**

Front cover opening switch. Press to open the Front Cover.

**⑤ Power Switch**

Turns the power on and off.

→See "Turning On and Off the Printer" on page 9 for instructions on turning the power on and off.

**⑥ Card Stacker**

A maximum of 250 cards\*<sup>1</sup> can be stacked by attaching the Card Ejection Slot (Left). Without good reason, there is no need to remove the Card Stacker.

→See the "Easy Setup Guide" for instructions on attaching.

**⑦ Card Ejection Slot (Left)**

Ejects correctly printed cards and cards with errors. You can select between Card Ejection Slot (Left) and (Right) for card ejection.

The factory default is set so both correctly printed cards are output from Card Ejection Slot (Left).

→See "Switching the Card Ejection Slot" on page 46 for information about switching the card ejection slot.

\*1 When using CR-80 cards (size: 3.375" × 2.125" (86 mm × 54 mm), thickness: 0.03" (0.76 mm)).



## Inside the Top Cover

Interior of the Top Cover.

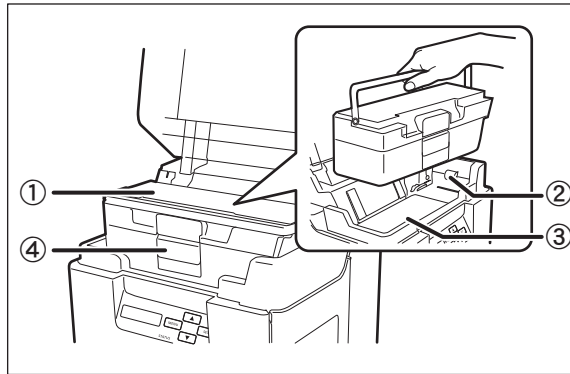

### ① Card Case

Up to 250<sup>\*1</sup> cards can be loaded at one time. You can adjust the gate gap to match the thickness of the fed cards. The factory default is set so the gap corresponds to feeding of cards of 0.76 mm in thickness.

→See "Loading Cards" on page 10 for instructions on loading cards.

→See "Cards" on page 82 for details about which cards you can use.

→See "Adjusting the Feed Gate Depending on Card Thickness" on page 42 for instructions on adjusting the gate gap.

### ② Feeding Roller

Pulls loaded cards into the printer.

→See "Cleaning the Feeding Roller" on page 59 for feeding roller cleaning instructions.

### ③ Top Cover

Open when cards are jammed or similar.

→See "When a Card is Jammed..." on page 73 for instructions on how to eject jammed cards.

### ④ Card Case Lock

When loading cards, pull the lock to open the card case.

→See "Loading Cards" on page 10 for instructions on loading cards.

---

\*1 When using CR-80 cards (size: 3.375" × 2.125" (86 mm × 54 mm), thickness: 0.03" (0.76 mm)).

## Rear Side of the Printer

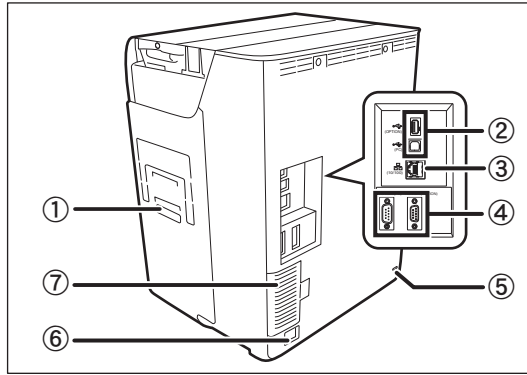

**① Card Ejection Slot (Right)**

Ejects correctly printed cards and cards with errors.

Card Ejection Slot (Left) or (Right) can be selected.

The factory default is set so cards with errors are output from Card Ejection Slot (Right).

→See "Switching the Card Ejection Slot" on page 46 for information about switching the card ejection slot.

**② USB Cable Port**

USB (A terminal) ×1 and USB (B terminal) ×1. Connect the B terminal and the computer using the provided USB cable. Additionally, connect the optional enhancement unit using the A terminal.

→See the "Easy Setup Guide" for instructions on connecting the cable.

**③ LAN Cable Port**

Connect to the network using the LAN Cable.

→See the "Easy Setup Guide" for instructions on connecting the cable.

**④ Port for Enhancing Function**

Used for enhancing function<sup>\*1</sup>

**⑤ Security Cable Slot**

Use the Security Cable Slot to prevent theft of the printer.

→See "Preventing Theft and Unauthorized Usage" on page 53 for instructions on using the Security Cable Slot.

**⑥ Power Cable Port**

Used to connect the Power Cable.

→See the "Easy Setup Guide" for instructions on connecting the cable.

**⑦ Filter**

Filters out airborne dirt and other foreign matter, preventing this entering the printer. The filter can be removed for cleaning.

→See "Filter Cleaning" on page 66 for filter cleaning instructions.

---

<sup>\*1</sup> Do not connect other than the specified optional units. Connecting these units could damage them.

## Front Cover

Interior of the Front Cover.

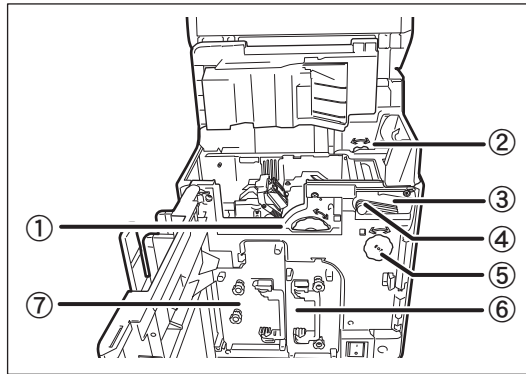

### ① Card Feeding Knob

Rotating the dial to the left or right ejects cards jammed in the secondary transfer section from the Card Ejection Slot (Left) or (Right).

→See "When a Card is Jammed..." on page 73 for instructions on how to eject jammed cards.

### ② Reverse Feeding Knob

Rotating the dial to the left or right ejects cards jammed in the card feed slot and reverse section.

→See "When a Card is Jammed..." on page 73 for instructions on how to eject jammed cards.

### ③ Cleaning Roller

Removes dirt and other foreign matter stuck to the cards.

→See "Cleaning the Cleaning Roller" on page 57 for cleaning instructions.

### ④ Cleaning Tape Cassette

Remove when replacing the Cleaning Tape.

→See "Cleaning Tape Replacement" on page 22 for how to change the Cleaning Tape.

### ⑤ Reverse Knob

Rotate the knob to the left to change the direction of the cards in the reverse section.

→See "When a Card is Jammed..." on page 73 for instructions on how to change the direction of cards in the reverse section.

### ⑥ Ink Ribbon Cassette

Ink Ribbon Cassette.

→See "Changing the Ink Ribbon and Transfer Film" on page 16 for details about changing the Ink Ribbon.

→See "Ink Ribbon/Transfer Film" on page 81 for details about which Ink Ribbon you can use.

### ⑦ Transfer Film Cassette

Transfer Film Cassette.

→See "Changing the Ink Ribbon and Transfer Film" on page 16 for details about changing the Transfer Film.

→See "Ink Ribbon/Transfer Film" on page 81 for details about which Transfer Film you can use.

# Operation Panel

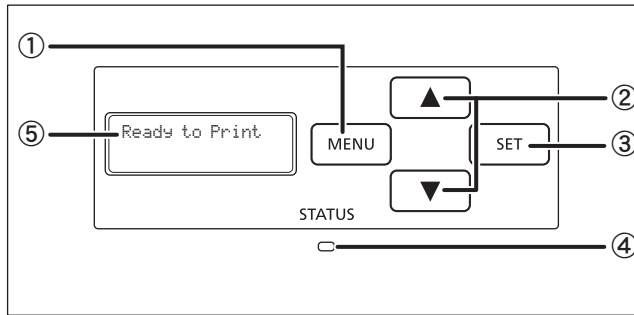

**① MENU Key**

Switches between Normal Mode and User Mode. In User Mode, it is used to go up one level of the menu.  
 →See "Normal Mode and User Mode" on page 23 for details about Normal Mode and User Mode.

**② ▲/▼ Keys**

In User Mode, used to select menus and settings values.

**③ SET Key**

Used to clear errors. In User Mode, this opens the display menu.  
 →See "Troubleshooting" on page 67 when an error occurs.  
 →See "Basic User Mode Operations" on page 25 for details on changing the User Mode settings.

**④ LED Indicator**

This indicator is lit blue depending on the status of the printer. Is lit or blinks orange when an error occurs.  
 →See "Troubleshooting" on page 67 when an error occurs.

**⑤ LCD Panel**

Displays the printer status.  
 →See "Normal Mode Message List" on page 23 for details of the display.



- You can check the status of the printer by looking at the LED Indicator.
  - LED Indicator is lit (blue) ... Ready for printing.
  - LED Indicator is blinking (blue, slow) ... Printer is in use.
  - LED Indicator is lit (orange) ... Cards or Ink Ribbon have run out.
  - LED Indicator is blinking (orange) ... Card jammed, or other error has occurred.

# Basic Card Printing Methods

This section explains the basic flow of operations, from turning on the power through printing a card.

## Turning On and Off the Printer

Turn on the printer before starting to print.

Before turning on the power, make sure the following preparations are complete:

- The Ink Ribbon Cartridge is loaded
- The Transfer Film is loaded
- The Front Cover is closed
- The Top Cover is closed
- The printer is connected to the computer
- The printer driver is installed



**REF**

- If the preparations above have not been performed, follow the instructions in the "Easy Setup Guide".

**1**

### Press the Power Switch to turn on the power.

- Press "-" on the Power Switch behind of the printer for turning on the power.
- After [Initializing..] appears on the LCD Panel, the operating indicator turns blue and [Ready to Print] appears.
- Press "O" on the Power Switch for turning off the power.

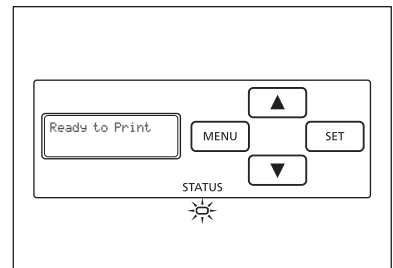

- If a card is in the printer when the power is turned on, it is ejected from Card Ejection Slot (Left) (default setting).



**REF**

- If the LED Indicator turns orange/blinks, refer to "Troubleshooting" on page 67.

## Loading Cards

Cards can be loaded in two ways: using the card retainer, and using the card feeding slot.

The Card Retainer can be loaded with a large quantity of cards, making it useful for mass printing. Use the Card Feeding Slot to manually load cards when you want to print only 1 particular card or to print many types of cards.



- In this manual, the direction of the card case and of cards is as below.

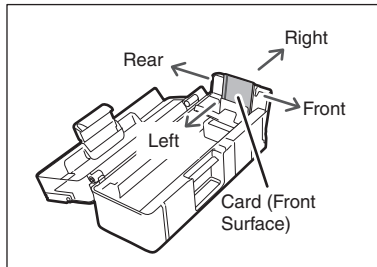

### CAUTION

- Use cards recommended by your reseller.  
→See "Cards" on page 82 for details about which cards you can use.
- Do not use the following cards:
  - Cards previously printed with this or any other card printer
  - Wet cards
  - Cards mixed with glass, metallic or other foreign objects
  - Embossed cards
  - Cards coated with oil or other foreign matter
  - Cracked, chipped, bent or otherwise damaged cards
  - Transparent cards
  - Abnormally shaped cards

## ■ Loading Cards into the Card Case

1

**Open the Top Cover, and the Card Case cover.**

- Pull the lock lever, and open the Card Case lid.

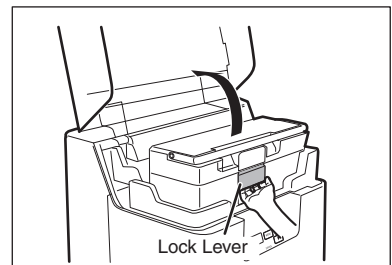

## 2 Pull the card retainer, and load cards.

- Hold the card retainer lever with your fingers, and pull it right out.
- Load the card case with the printing side (front surface) to the left.
- When loading the cards, be sure to hold their edges, and never touch the front or rear printing sides.

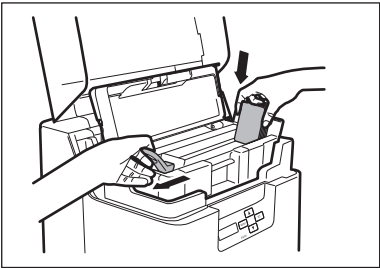
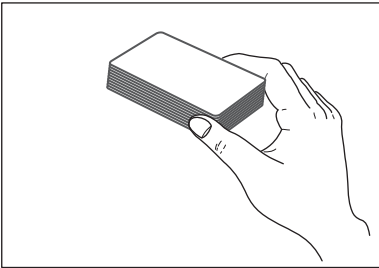

## 3 Return the card retainer, and close the cover.

- When returning the card retainer, be sure not to get your fingers caught.
- Confirm that the card touches the upper roller of the feeder.

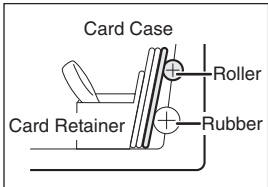

## 4 Close the Top Cover.

**Note**

- The Card Case can be removed from the printer. After loading the cards as in the diagram at right, return the card retainer to its original position, close the cover, and reattach to the printer.

→See "How to Store Cards (Removing the Card Case)" on page 53 for information on how to remove the Card Case.

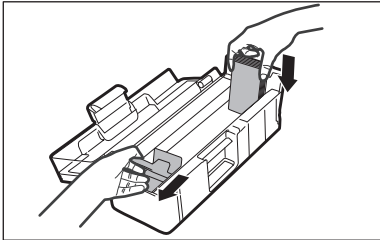

- In order to prevent unauthorized printing, we recommend storing loaded Card Cases separately from the printer.

→See "How to Store Cards (Removing the Card Case)" on page 53 for information on how to store the Card Case.

- Load cards in order starting from the right side of the card case. When printing begins the right-most card is pulled into the printer.

- The printing side of the card (front surface) is on the left.

When using cards such as pre-printed cards that have a specified orientation, load the cards so that after printing, the printed upper surface is at the rear of the cassette.

- If cards are stuck to each other and do not correctly feed, then lightly flex and separate the cards before printing.

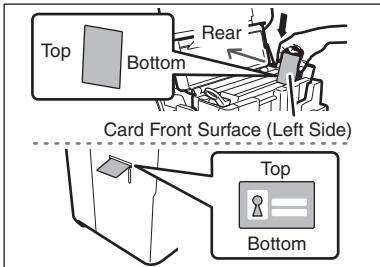

## ■ Manually Loading Cards One by One

### 1 Open the Top Cover.

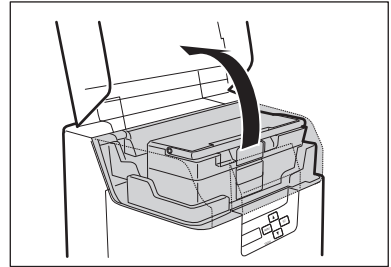

### 2 Open the Card Case, and insert cards into the Card Feeding Slot.

- Pull the lock, and open the Card Case lid.
- Insert cards with the printing side to the left into the Card Feeding Slot.
- If cards are loaded, remove them from the Card Case.

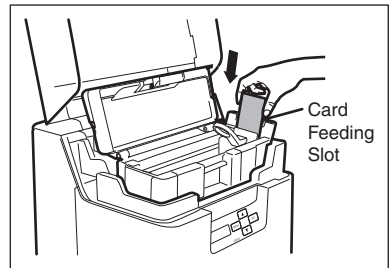

**Note**

- The printing side of the card (front surface) is the left surface. When using cards such as pre-printed cards that have a specified orientation, load the cards so that after printing, the printed upper surface is at the rear of the cassette.

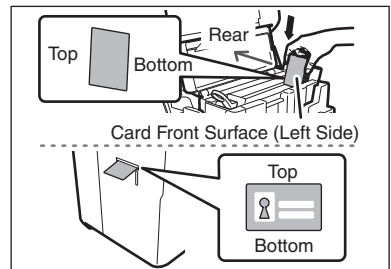



## ■ Loading Magnetic/IC Cards

The factory default for magnetic cards/IC cards is to be loaded as below.

→See "Loading Cards into the Card Case" on page 10 for the procedure on loading cards into the Card Case.

### If using cards with JIS2 magnetic strips

- Load the JIS2 magnetic strips so that they are at the left of the Card Case.
- Load the JIS2 magnetic strips so that they are at the rear of the Card Case.

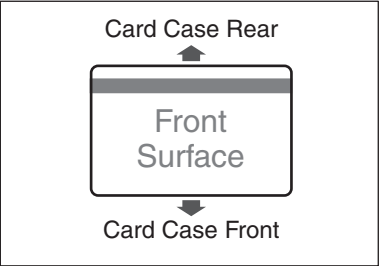

### If using cards with ISO magnetic strips

- Load the ISO magnetic strips so that they are at the right of the Card Case.
- Load the ISO magnetic strips so that they are at the rear of the Card Case.

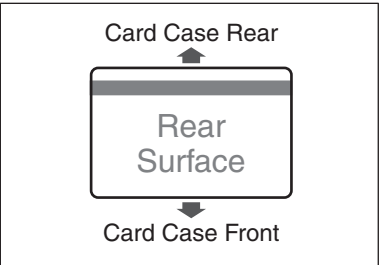

### If using cards with IC terminals

- Load the IC terminals so that they are at the left of the Card Case.
- Load the IC terminals so that they are at the rear of the Card Case.

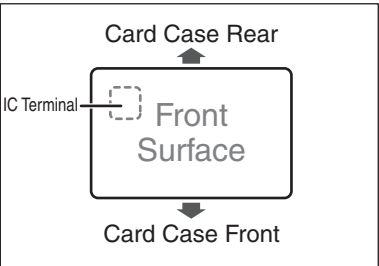

**Note**

- Printing on the magnetic strip/IC terminal cannot be guaranteed.
- The surface with the JIS2 magnetic strip and the IC terminal is the printing side (front surface).
- In User Mode, [Set Face], you can set the orientation of loaded magnetic cards.  
→See "Set the Orientation of Magnetic Cards/IC Cards to Load" on page 47 for information on how to load magnetic cards.

# Printing



- Command/menu names and the order of the procedure may differ depending on your application software. For more information on operations, refer to the instruction manual for your application software.
- Also, for more information about printer driver operations, refer to the driver help files.
- The explanations in this manual are based on screens that appear when using Windows 7.

## 1 Turn on the printer and load the cards.

- See "Loading Cards" on page 10 for information on how to load the cards correctly.

## 2 Launch your application software to create a document.

## 3 From the [File] menu of your application software, select [Print].

- Open the printer driver settings screen.

## 4 Specify various settings for printing if necessary.

- Select [NISCA PR-C201] if it is not already selected.
- Click [Preferences] (or [Properties]), and set the card size and the number of cards to be printed. Click [OK] when setup is complete.

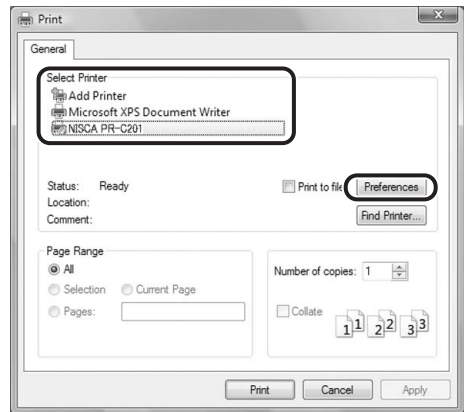

- For more information about how to change the settings of the printer driver, refer to the driver help files.

5

Click [Print].

- Printing starts.
- Cards are pulled into the printer and the LED Indicator blinks blue.  
[Now Printing] appears on the LCD Panel.
- If the cards are not loaded, [Card Empty] appears on the LCD Panel.

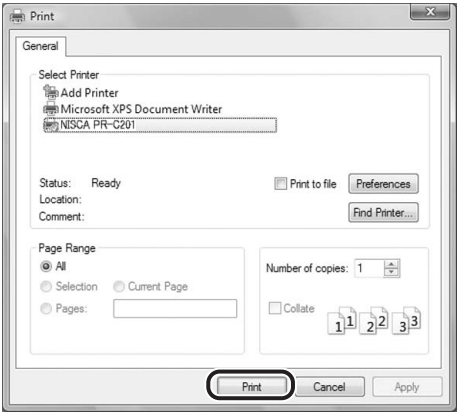

Removing Cards

The factory default is for printed cards to be ejected from Card Ejection Slot (Left).

1

Removing cards from the Card Stacker.

- You can remove loaded cards from the slit on the side of the Card Stacker (see diagram at right).

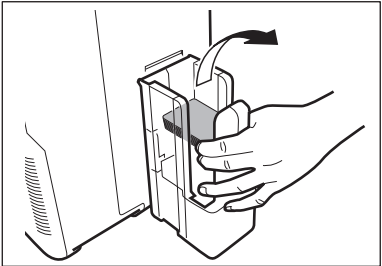

Note

- The Card Ejection Slot (Left) Card Stacker has a maximum capacity of approximately 250 cards.  
When ejecting cards from the Card Ejection Slot (Left), empty the Card Stacker when it has approximately 250 cards.
- The factory default is set so that correctly printed cards are output from the Card Ejection Slot (Left), and cards with errors are output from Card Ejection Slot (Right).  
→See "Switching the Card Ejection Slot" on page 46 for information about switching the card ejection location.  
→See the "Easy Setup Guide" for instructions on removing the Card Stacker.
- The factory default status is to have the front face facing down for single-sided printing, and facing up for double-sided printing.  
→See "Set the Orientation of Cards to Eject" on page 49 for the orientation of cards to eject.

## Changing the Ink Ribbon and Transfer Film

Change the Ink Ribbon and Transfer Film when these run out.

→See "Ink Ribbon/Transfer Film" on page 81 for details about Ink Ribbon and Transfer Film.

**Note**

- You can check the amount of Ink Ribbon and Transfer Film remaining.  
→See "Correcting image and text misalignment" on page 36 for instructions on how to check the amount of Ink Ribbon and Transfer Film remaining.

### ■ Checking Replacement Period, and Preparation

If [Ribbon Empty] or [Film Empty] messages are displayed on the LCD panel, then it is necessary to replace the Ink Ribbon or Transfer Film.

This section explains how to change the Cleaning Tape together with the Ink Ribbon and Transfer Film.

#### 1 Before replacement, open the Front Cover.

- Press the open cover switch, and pull the Front Cover out.  
→See "Changing the Ink Ribbon" on page 17 when replacing the Ink Ribbon.  
→See "Cleaning Tape Replacement" on page 22 when replacing the Cleaning Tape.  
→See "Transfer Film Replacement" on page 19 when replacing the Transfer Film.

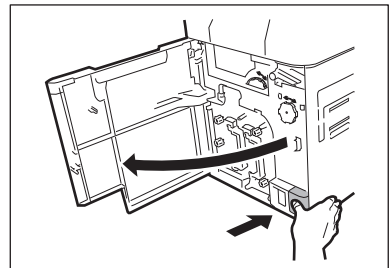

**Note**

- The Ink Ribbon, Transfer Film, and Cleaning Tape can be replaced while the Front Cover is open.
- The number of printable sides with the Ink Ribbon and Transfer Film may decrease under the following conditions:  
→See "Ink Ribbon/Transfer Film" on page 81 for the number of printable sides with Ink Ribbon and Transfer Film.
  - Changing the Ink Ribbon or Transfer Film during use
  - When an error occurs during printing
  - Performing operations not listed in this manual
- Use Ink Ribbon and Transfer Film as soon as possible after purchase.

## ■ Changing the Ink Ribbon

Use the following procedure when replacing the Ink Ribbon.

### 1 Remove the Ink Ribbon Cassette.

- Pull out the handle of the ink ribbon cassette with the handle turned up.

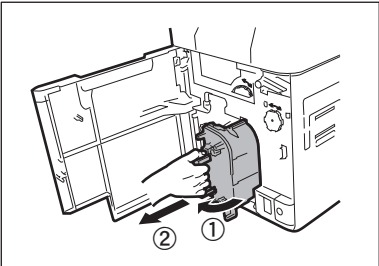

- Note**
- When placing the Ink Ribbon Cassette down, prevent contamination adhering by placing it with the handle on the bottom.

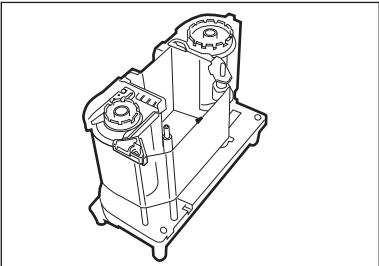

### 2 Remove the Ink Ribbon from the Cassette.

- First, remove the spool spindle from the winding side (black) holder, then remove the spool spindle from the feed side (magenta) holder.
- When removing the spool spindle, pressing the spool spindle downwards and tilting it to the side makes it easy to remove.

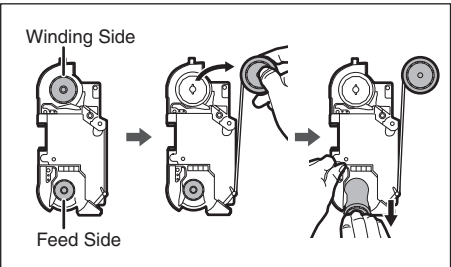

### 3 Load new Ink Ribbon in the Cassette.

- Insert the spool spindle into the feed side (magenta) holder. As in the diagram at right, unwind and load onto the shaft. Finally, insert the spool spindle into the winding side holder.
- When inserting the spool spindle, first inserting the bottom, then standing the spool spindle makes it easy to insert.
- When setting the used Ink Ribbon, take up used parts of the ribbon to the spool spindle for the winding side (black). Otherwise, images may not be printed on a card correctly.

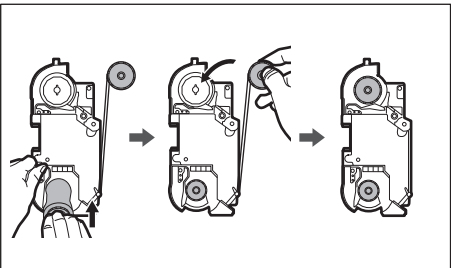

## Full Color Card Printer

### 4 Take up the Ink Ribbon slack.

- Turn the knob as in the diagram at right, and take up the ribbon slack.
- If the slack is not taken up properly, then the Ink Ribbon may jam.

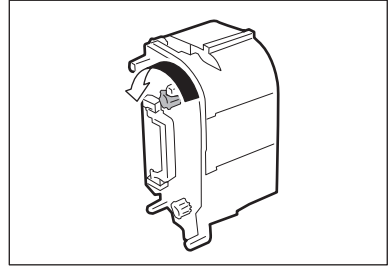

### 5 Insert the Ink Ribbon Cassette.

- Insert the Ink Ribbon Cassette until a "click" is heard.  
→For replacing Transfer Film or Cleaning Tape, See "Transfer Film Replacement" on page 19, or "Cleaning Tape Replacement" on page 22.

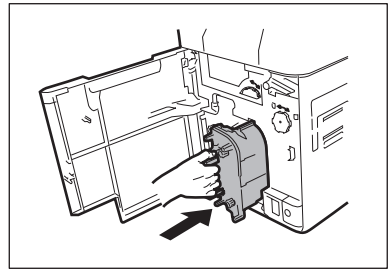

#### Note

- When inserting the Ink Ribbon Cassette, insert while turning the knob in order to prevent slack. Slack of Ink Ribbon may lead to print abnormalities.

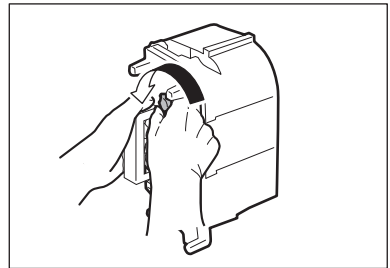

### 6 Close the Front Cover.

### 7 When [Push SET key] appears on the screen, press the SET Key.

- Clear an error first if the error message such as [Card Empty] appears, then press the SET Key.  
→See "When an Error Message Appears" on page 67 for clearing error messages.

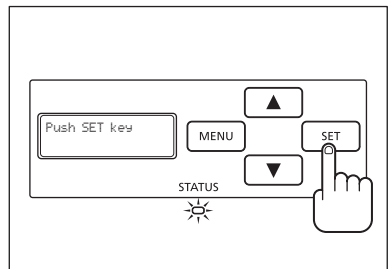

## ■ Transfer Film Replacement

Use the following procedure when replacing the Transfer Film.

### 1 Remove the Transfer Film Cassette.

- Pull out the handle of the transfer film cassette with the handle turned up.

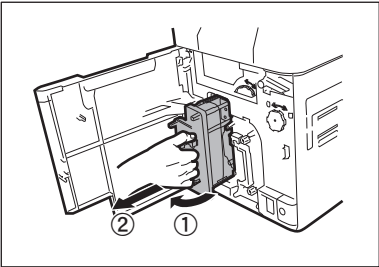

- Note**
- When placing the Transfer Film down, prevent contamination adhering by placing it with the handle on the bottom.

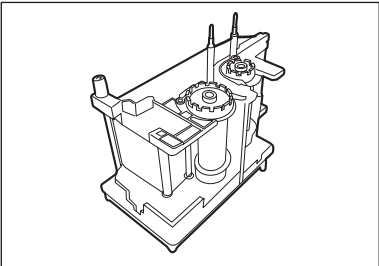

### 2 Push down the pin on top of the Transfer Film Cassette.

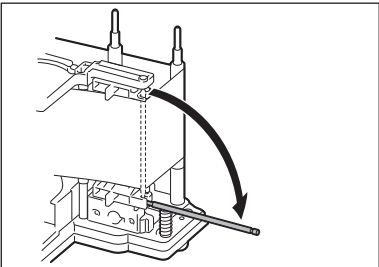

### 3 Remove the Transfer Film from the Cassette.

- First, remove the spool spindle from the winding side (black) holder, then remove the spool spindle from the feed side (white) holder.
- When removing the spool spindle, pressing the spool spindle downwards and tilting it to the side makes it easy to remove.

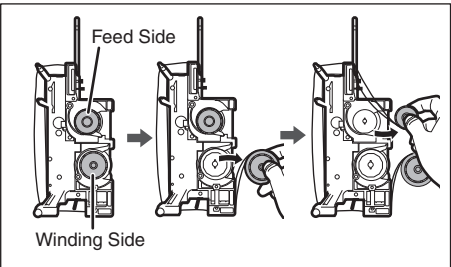

## Full Color Card Printer

### 4 Load new Transfer Film in the Cassette.

- Insert the spool spindle into the feed side (white) holder. As in the diagram at right, unwind and load onto the shaft. Finally, insert the spool spindle into the winding side holder.
- When inserting the spool spindle, first inserting the bottom, then standing the spool spindle makes it easy to insert.
- When setting the used Transfer Film, take up unused parts of the film to the spool spindle for the feed side (white). Otherwise, images may not be transferred to a card correctly.

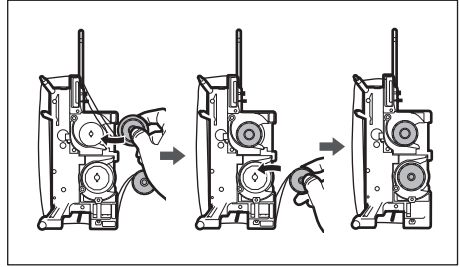

### 5 Attach the pin on top of the Transfer Film Cassette.

- Tightly fit the tip of the pin into the grooves.

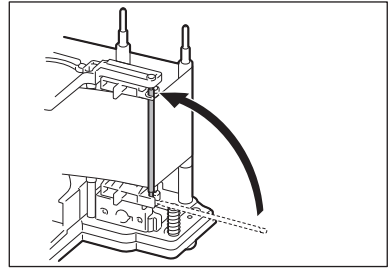

#### Note

- Make sure that the Transfer Film is running between the two pins on top of the Transfer Film Cassette.

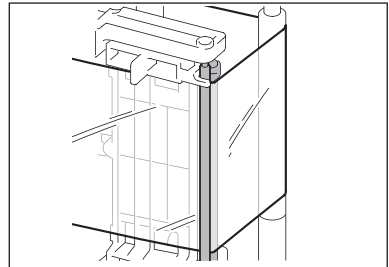

### 6 Take up the Transfer Film slack.

- Turn the knob as in the diagram at right, and take up the film slack.
- If the slack is not taken up properly, then the Transfer Film may jam.

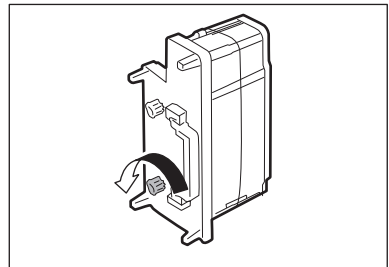



## 7

**Insert the Transfer Film Cassette.**

- Insert the Transfer Film Cassette until a "click" is heard.  
→For replacing Cleaning Tape, See "Cleaning Tape Replacement" on page 22.

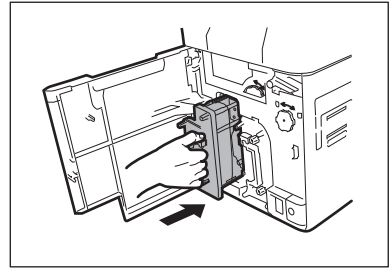
**Note**

- When inserting the Transfer Film, insert while turning the knob in order to prevent slack. Slack of Transfer Film may lead to print abnormalities.

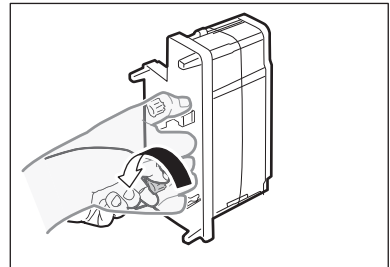

## 8

**Close the Front Cover.**

## 9

**When [Push SET key] appears on the screen, press the SET Key.**

- Clear an error first if the error message such as [Card Empty] appears, then press the SET Key.  
→See "When an Error Message Appears" on page 67 for clearing error messages.

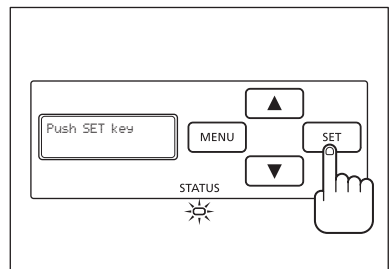

## ■ Cleaning Tape Replacement

### 1 Remove the Cleaning Tape Cassette.

- Hold the Cleaning Tape Cassette handle, lift it, and pull.

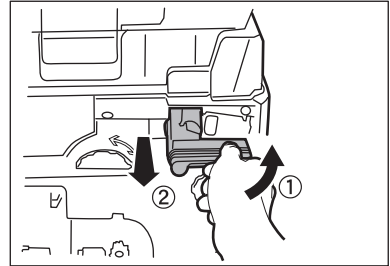

### 2 Lift up the tape spindle.

- As in the diagram at right, lift the tape spindle by hand.

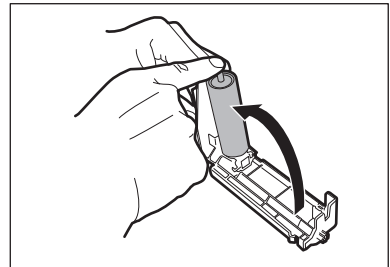

### 3 Remove the used Cleaning Tape, insert the new tape, and return the tape spindle.

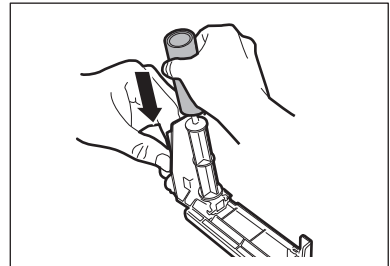

### 4 Insert the Cleaning Tape Cassette.

- Set the slide of the Cleaning Roller with the rail on the printer and insert it all the way.

### 5 Close the Front Cover.

### 6 When [Push SET key] appears on the screen, press the SET Key.

- Clear an error first if the error message such as [Card Empty] appears, then press the SET Key.  
→See "When an Error Message Appears" on page 67 for clearing error messages.

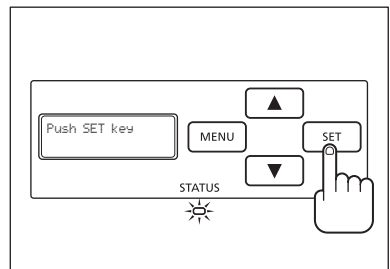

- 
- **Note** A protective tape is attached to the new Cleaning Tape. Use the cleaning tape after removing the protective tape.

# Normal Mode and User Mode

You can switch the printer from Normal Mode to User Mode while it is operating. This section provides an outline of both modes, explains how to change modes and explains the basic operations of the User Mode.

## Normal Mode and User Mode

### ■ Normal Mode

Normal Mode is used for printing cards. When the power is turned on the printer starts in Normal Mode.

The printer status, such as [Ready to Print] and [Now Printing] appears on the LCD Panel. Additionally, details of errors, such as [Ribbon Empty] appear.

In Normal Mode, while the ▲ Key is pressed, you can confirm the remaining Ink Ribbon and Transfer Film (diagram at right). Releasing the ▲ Key returns the display to the standard Normal Mode display.

A single "\*" indicates approximately 20% remaining. When this is not displayed, then replacement of the Ink Ribbon or Transfer Film is necessary.

Additionally, if "\*" is blinking, this indicates that it is nearly time for replacement.

→See "Changing the Ink Ribbon and Transfer Film" on page 16 for details about changing the Transfer Film or Transfer Film.

→See "Correcting image and text misalignment" on page 36 for instructions on how to check the remaining quantities from User Mode.

→See "Notification of Time for Ink Ribbon and Transfer Film Replacement" on page 41 for setting replacement times.

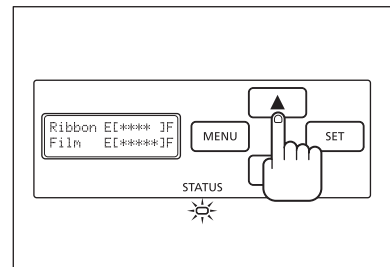
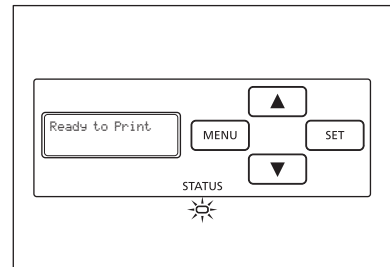

### Normal Mode Message List

Initializing	The printer is initializing. Remaining cards (abnormal card) are ejected from the card ejection slot.
Ready to Print	In standby. This is awaiting a request to print cards.
Now Printing	Printing cards.

## ■ User Mode

User Mode is used to set operations and check the status of the printer.

Menu names such as [Card Count] and [Ribbon Type] appear on the LCD Panel.

### Switching to User Mode

This section explains how to switch from Normal Mode to User Mode.

→See "Switching to Normal Mode (Exiting User Mode)" on page 26 for how to switch from User Mode to Normal Mode.

#### 1 Press the Power Switch to turn on the power.

- When the power starts and the printer turns on in Normal Mode, and [Ready to Print] appears on the LCD Panel.

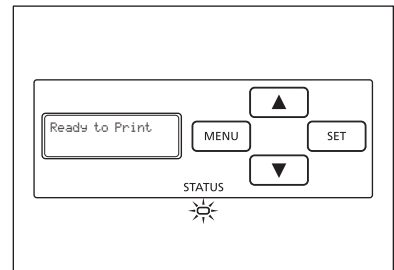

#### 2 Press the MENU Key.

- The User Mode top menu is displayed on the LCD Panel.

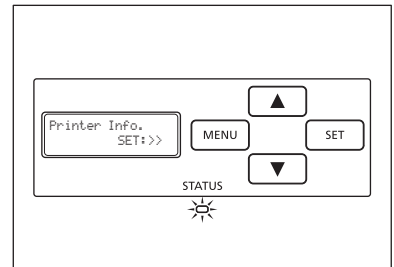

**Note**

- You can use the procedure above to enter the User Mode even when a printer error occurs.
- While the top menu is displayed, pressing the MENU Key will display [Exit Menu ?]. Then pressing the SET Key will return to Normal Mode.

## Basic User Mode Operations

The User Mode has multiple menus in a hierarchical tree organized according to function.

This section explains how to switch menus in the User Mode hierarchy tree and how to switch from User Mode to Normal Mode.

→See "Menu Route Map (User Mode)" on page 84 for details about the menu tree configuration.

→See "Printer Settings" on page 27 for details on the functions of each menu.

### Note

- Look at "Menu Route Map (User Mode)" on page 84 while reading this section.

### ■ Moving to the Next Menu (Switching to Menus on the Same Level)

You can move to the next menu from any menu in the User Mode by pressing the ▼ Key.

Press the ▲ to return to the previous menu.

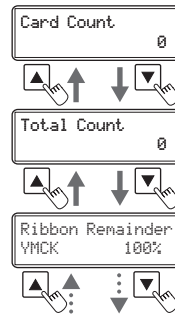

### ■ Moving to a Sub-menu (Switching to Menus on a Lower Level)

You can move to available sub-menus by pressing the SET Key ([SET:>>]) on a menu's right indicates a sub-menu).

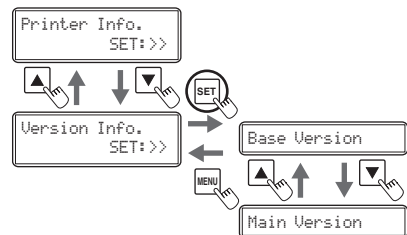

### ■ Returning to the Main Menu (Switching to Menus on a Higher Level)

You can return to a higher level by pressing the MENU Key. You can return to the main menu by pressing the MENU Key several times.

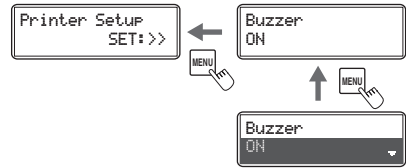

### ■ Switching to Normal Mode (Exiting User Mode)

After pressing the MENU Key several times to display [Exit Menu ?], you can return to Normal Mode by pressing the SET Key.

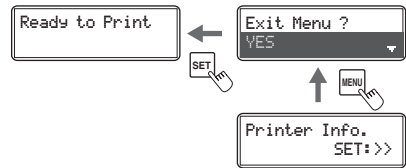

After pressing the ▼ Key several times to display [NO], you can return to User Mode by pressing the SET Key.

---

#### Important

- After changing settings values using the ▲/▼ Keys in each menu, press the SET Key to make the changes. Either pressing the MENU Key or turning off the power without pressing the SET Key will mean that changes are not saved in the printer. (Changed contents are saved when the SET Key is pressed.)

# Printer Settings

This section explains how to check the printer's status and change the printer's settings.

## Counting the Number of Cards that Are Printed

You can count the number of cards that are printed.

You can also count the number of cards that have been printed in a specified period of time by resetting the count with the SET Key.

### Note

- You can also count the number of cards printed by using the printer driver (→See "Opening the Printer Driver Settings Screen" on page 87).

### 1 Switch from Normal Mode to User Mode.

→See "Switching to User Mode" on page 24 for details on how to switch to User Mode.

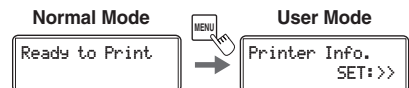

### 2 Confirm that [Printer Info.] appears, and press the SET Key.

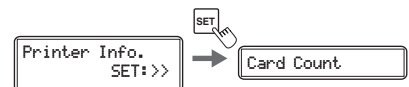

### 3 Confirm the [Card Count] display.

- The number of cards that are printed appears.

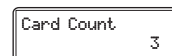

To reset the value, proceed to Step 4.

## Full Color Card Printer

### 4 Press the SET key.

- The display changes to [Reset ?].

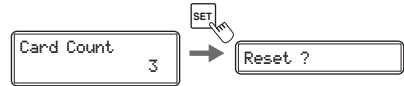

### 5 Change the setting to [YES] by using the ▲/▼ Keys then press the SET key.

- The display returns to [Card Count] and the value becomes [0].

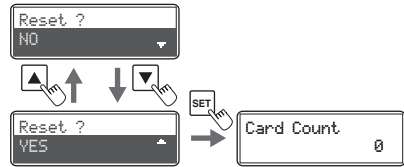

## Displaying the Total Number of Sides that Are Printed

You can display the total number of sides (each card has two sides) that are printed. This can be used as a guideline for doing maintenance.

#### Note

- You can also display the status on the printer driver (→See "Opening the Printer Driver Settings Screen" on page 87).

### 1 Switch from Normal Mode to User Mode.

→See "Switching to User Mode" on page 24 for details on how to switch to User Mode.

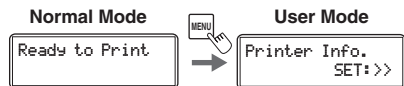

### 2 Confirm that [Printer Info.] appears, and press the SET Key.

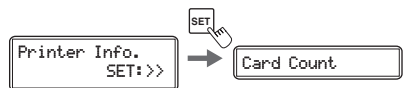



### 3 Press the ▼ Key until [Total Count] is displayed.

- The total number of sides is displayed.

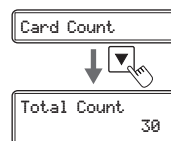

**CAUTION** • The count cannot be reset.

## Checking the type and remaining quantity of the Ink Ribbon or Transfer Film

You can check the type and remaining quantity of the Ink Ribbon or Transfer Film.

→See "Setting the Type of Ink Ribbon or Transfer Film to Use" on page 39 for details on how to set the Ink Ribbon or Transfer Film type.

**Note**

- You can also display the status on the printer driver (→See "Opening the Printer Driver Settings Screen" on page 87).

### 1 Switch from Normal Mode to User Mode.

→See "Switching to User Mode" on page 24 for details on how to switch to User Mode.

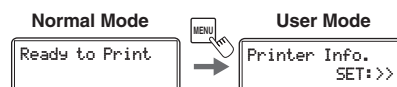

### 2 Confirm that [Printer Info.] appears, and press the SET Key.

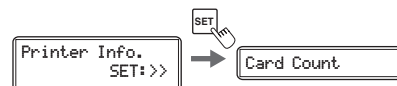

### 3 Press the ▼ Key until [Ribbon Remainder] or [Film Remainder] appears.

- [Ribbon Remainder] displays the type and remaining quantity of the Ink Ribbon as a percentage.
- [Film Remainder] displays the type and remaining quantity of the Transfer Film as a percentage.

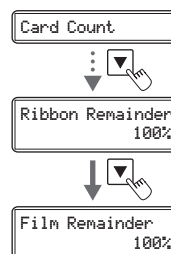

## Checking the Program Version and Serial Number

You can check the version of the program and the printer's serial number.

- Note**
- You can also display the status on the printer driver (→See "Opening the Printer Driver Settings Screen" on page 87).
  - You can confirm the following information.
    - **Version of the base program (display is [Base Version])**
    - **Version of the main program (display is [Main Version])**  
**The version of the program that starts when the power is turned on.**  
 You can download a file to update the program.  
 →See "Updating the Printer's Software" on page 83 for updating instructions.
    - **Printer's serial number (display is [Serial Number])**
    - **Head serial number (display is [Head Number])**
    - **Magnetic encoder version (display is [Magnetic Encoder])**  
 Magnetic encoder specifications (ISO/JIS2) and version information.
    - **IC R/W connection status (display is [IC R/W 1], [IC R/W 2])**
    - **External box connection status (display is [External Box])**

### 1 Switch from Normal Mode to User Mode.

→See "Switching to User Mode" on page 24 for details on how to switch to User Mode.



### 2 Press the ▼ Key until [Version Info.] is displayed, then press the SET Key.

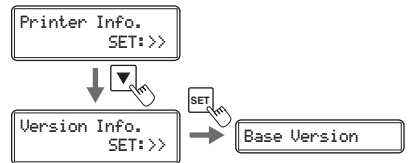

### 3 Press the ▲/▼ Keys to display the information to check.

- The ▲/▼ Keys switch between [Base Version] ↔ [Main Version] ↔ [Serial Number] ↔ [Head Number] ↔ [Magnetic Encoder] ↔ [IC R/W 1] ↔ [IC R/W 2] ↔ [External Box].

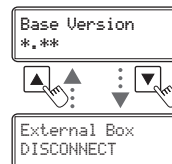

## Turning the Error Alarm On or Off

The initial setting is for the buzzer to sound when an error occurs. You can set the buzzer so that it does not sound.

### Note

- You can also change the settings by using the printer driver (→See "Opening the Printer Driver Settings Screen" on page 87).

### 1 Switch from Normal Mode to User Mode.

→See "Switching to User Mode" on page 24 for details on how to switch to User Mode.

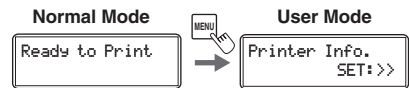

### 2 Press the ▼ Key until [Printer Setup] is displayed, then press the SET Key.

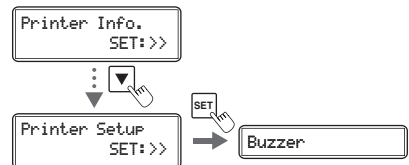

### 3 Confirm that [Buzzer] appears, and press the SET Key.

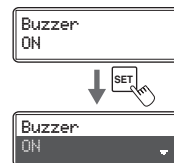

### 4 Change the settings by using the ▲/▼ Keys, then press the SET Key.

- Pressing the ▲/▼ Keys switches between [ON] and [OFF].
- Set it to [ON] to sound the buzzer or [OFF] to turn the buzzer off.

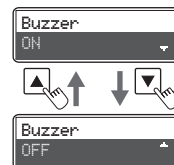

# Reduce Printer Power Consumption

Select the power-saving mode for when the printer is not being used.

**Note** • You can also change the settings by using the printer driver (→ See "Opening the Printer Driver Settings Screen" on page 87).

## 1 Switch from Normal Mode to User Mode.

→See "Switching to User Mode" on page 24 for details on how to switch to User Mode.

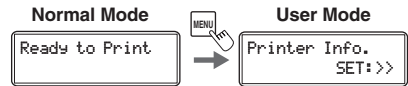

## 2 Press the ▼ Key until [Printer Setup] is displayed, then press the SET Key.

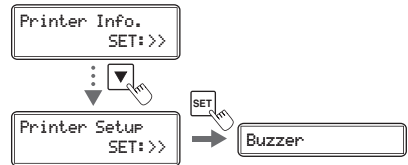

## 3 Press the ▼ Key until [Power Save Mode] is displayed, then press the SET Key.

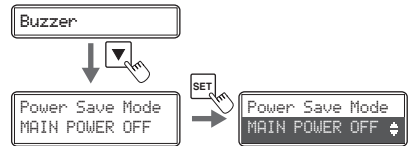

## 4 Change the settings by using the ▲/▼ Keys, then press the SET Key.

- Pressing the ▲/▼ Keys switches between [HEATER OFF] ⇔ [MAIN POWER OFF] ⇔ [KEEP READY].
- Settings values are as below.

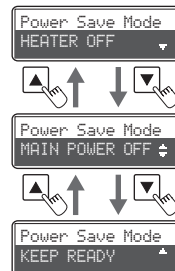

Settings Value	Details
HEATER OFF	If the heater is in standby for one hour, the heater will turn off.
MAIN POWER OFF	If the heater is in standby for one hour, the printer will turn off.
KEEP READY	The printer is always in a ready-to-print state. (power-saving mode off)

**Note**

- The factory default setting is [MAIN POWER OFF].
- If the printer is off ([MAIN POWER OFF]), turn it on by pressing the Power Switch to use it (→See "Turning On and Off the Printer" on page 9).

## Adjusting the Print Results

You can adjust the print results by changing the hue and the strength of the edge.

**Note**

- You can also change the settings by using the printer driver (→See "Opening the Printer Driver Settings Screen" on page 87).

### ■ Adjusting the printing position

You can adjust the printing position (vertical/horizontal) of the image and black text that will be printed on the card.

#### 1 Switch from Normal Mode to User Mode.

→See "Switching to User Mode" on page 24 for details on how to switch to User Mode.

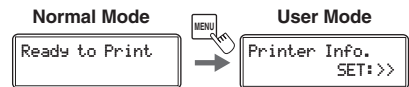

#### 2 Press the ▼ Key until [Printer Setup] is displayed, then press the SET Key.

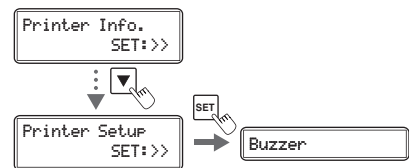

#### 3 Press the ▼ Key until [Print Vertical] or [Print Horizontal] is displayed, then press the SET key.

- Adjust the vertical printing position using the [Print Vertical] menu and adjust the horizontal printing position using [Print Horizontal].

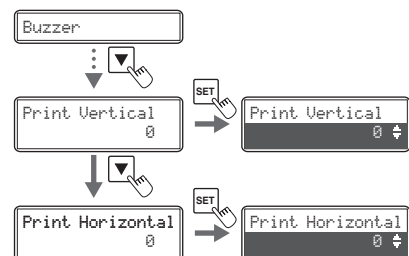

## Full Color Card Printer

### 4 Change the settings by using the ▲/▼ Keys, then press the SET key.

- If you increase the setting value of [Print Vertical] , the printing position will move downwards. (Setting values are by increments/decrements of approximately 0.04 mm)
- If you increase the setting value of [Print Horizontal] , the printing position will move to the right. (Setting values are by increments/decrements of approximately 0.1 mm)

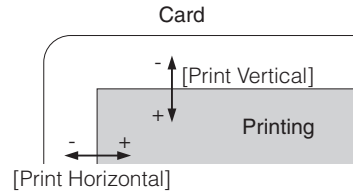
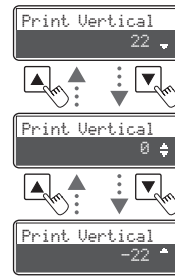

#### Note

- The optimum value is set for each unit as factory default.

## ■ Quality printing/Quick printing

You can change the printing speed of color images.

Quick printing is set as a factory default. You can perform quality printing by changing the settings.

### 1 Switch from Normal Mode to User Mode.

→See "Switching to User Mode" on page 24 for details on how to switch to User Mode.

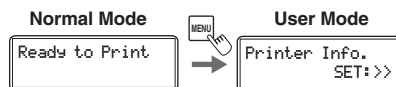

### 2 Press the ▼ Key until [Image Setup] is displayed, then press the SET Key.

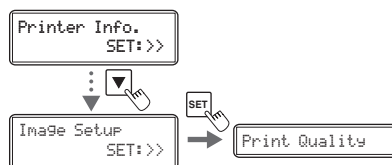

### 3 Confirm that [Print Quality] appears, and press the SET Key.

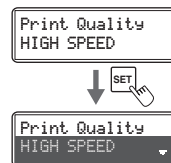

### 4 Change the settings by using the ▲/▼ Keys, then press the SET Key.

- Pressing the ▲/▼ Keys switches between [HIGH SPEED] and [HIGH QUALITY].
- Set the setting to [HIGH SPEED] for quick printing, and [HIGH QUALITY] for quality printing.

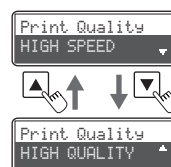

#### Note

- If the setting is set to [HIGH SPEED] the contrast of the color image will be reduced. In [Graphics] - [Detailed setting of Black], we recommend setting the [Printing method of color data] to [Print in color(CMY) and black(K)]. If you set the print quality to [HIGH QUALITY], we recommend setting the [Printing method of color data] to [Print in color (CMY) only].

## ■ Correcting image and text misalignment

You can correct the misalignment (horizontal) of the color image and black text printing position.

### 1 Switch from Normal Mode to User Mode.

→See "Switching to User Mode" on page 24 for details on how to switch to User Mode.

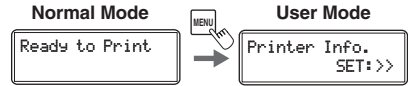

### 2 Press the ▼ Key until [Image Setup] is displayed, then press the SET Key.

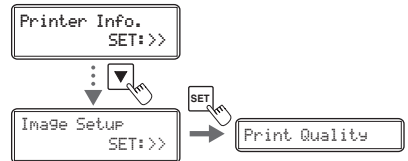

### 3 Press the ▼ Key until [Black Correction] is displayed, then press the SET Key.

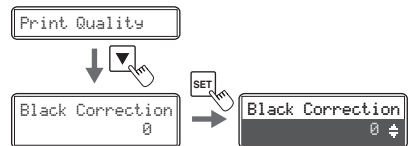

### 4 Change the settings by using the ▲/▼ Keys, then press the SET Key.

- If you increase the setting value, the black text will move towards the right of the color image. (Setting values are by increments/decrements of approximately 0.1 mm)

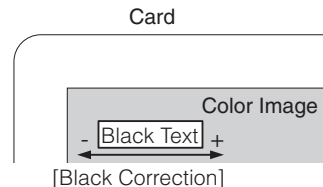
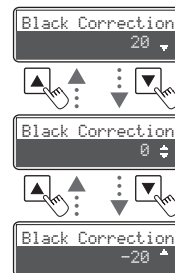



## ■ Adjusting the contour level

You can adjust the sharpness of edges such as facial contour.

### 1 Switch from Normal Mode to User Mode.

→See "Switching to User Mode" on page 24 for details on how to switch to User Mode.

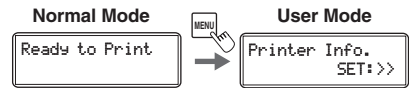

### 2 Press the ▼ Key until [Image Setup] is displayed, then press the SET Key.

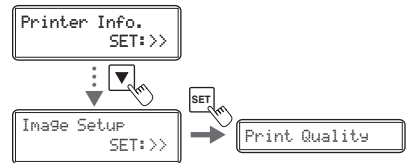

### 3 Press the ▼ Key until [Sharpness] is displayed, then press the SET Key.

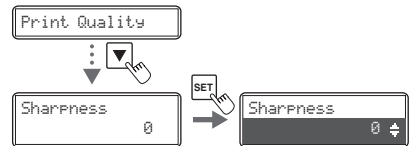

### 4 Change the settings by using the ▲/▼ Keys, then press the SET Key.

- If you increase the setting value, contours will be more pronounced. If you increase the setting value too much, the image quality may appear grainy.



## ■ Adjusting the hue

You can adjust the level of each hue (Yellow, Magenta, Cyan, Black). Adjusting the levels changes the hues of Yellow, Magenta, and Cyan for color images, and the thickness of black text for Black printing.

### 1 Switch from Normal Mode to User Mode.

→See "Switching to User Mode" on page 24 for details on how to switch to User Mode.

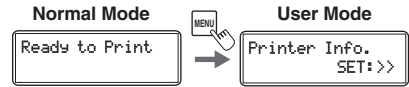

### 2 Press the ▼ Key until [Image Setup] is displayed, then press the SET Key.

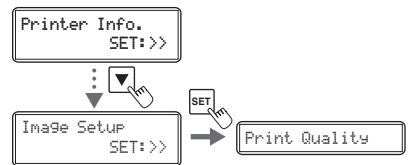

### 3 Press the ▼ Key until [Balance Yellow], [Balance Magenta], [Balance Cyan], or [Balance Black] is displayed, then press the SET key.

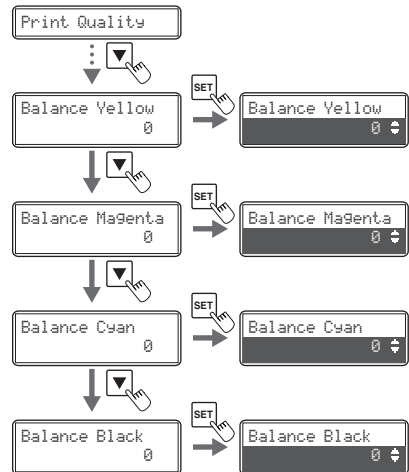

### 4 Change the settings by using the ▲/▼ Keys, then press the SET key.

- If you increase the setting value, the level of the selected color will increase.
- If you decrease the setting value, the level of the selected color will decrease.



## Setting the Type of Ink Ribbon or Transfer Film to Use

Set the type of Ink Ribbon or Transfer Film to use.

→See "Changing the Ink Ribbon and Transfer Film" on page 16 for details about changing the Ink Ribbon and Transfer Film.

→See "Ink Ribbon/Transfer Film" on page 81 for details about which Ink Ribbon and Transfer Film you can use.

**Note**

- You can also display the status on the printer driver (→See "Opening the Printer Driver Settings Screen" on page 87).

### 1 Switch from Normal Mode to User Mode.

→See "Switching to User Mode" on page 24 for details on how to switch to User Mode.

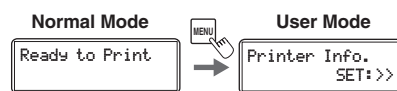

### 2 Press the ▼ Key until [Ribbon Setup] is displayed, then press the SET Key.

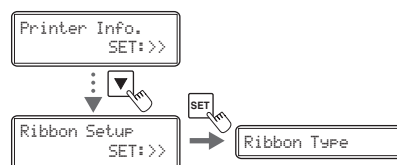

### 3 Press the ▼ Key until [Ribbon Type] or [Film Type] is displayed, then press the SET key.

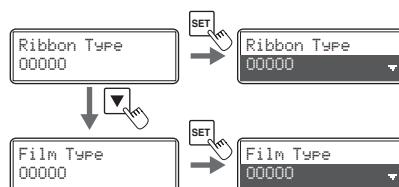

# 4 Change the settings by using the ▲/▼ Keys, then press the SET Key.

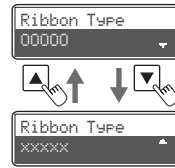

**Note**

- If the Ink Ribbon type set in the printer and the [Ribbon Type] setting are different, an Ink Ribbon error or a transfer problem occurs.
  - See "Ribbon Type" and "Ribbon Wind up" in "How to Clear an Error" on page 67.
  - See "General Print Problems (In correct Colors, etc.)" in "When Cards are Not Printed Correctly..." on page 78 about signs of transfer problems.
- If the set Transfer Film type and the [Film Type] setting on the printer are different, a transfer error occurs since the transfer condition is not appropriate.
  - See "The card is bent" and "Print flakes off" in "When Cards are Not Printed Correctly..." on page 78 about signs of transfer problems.

## Notification of Time for Ink Ribbon and Transfer Film Replacement

If there is little remaining Ink Ribbon or Transfer Film, the LCD Panel will display the remaining quantity to notify you that it should be replaced soon.

### Note

- You can also change the settings from the printer driver (→See "Opening the Printer Driver Settings Screen" on page 87).
- The factory default status is not to give this notification.

### 1 Switch from Normal Mode to User Mode.

→See "Switching to User Mode" on page 24 for details on how to switch to User Mode.

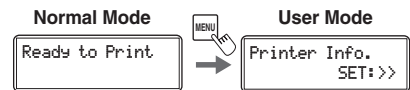

### 2 Press the ▼ Key until [Ribbon Setup] is displayed, then press the SET Key.

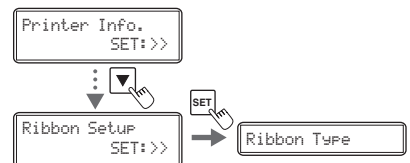

### 3 Press the ▼ Key until [Ribbon Notice(%)] or [Film Notice(%)] is displayed, then press the SET Key.

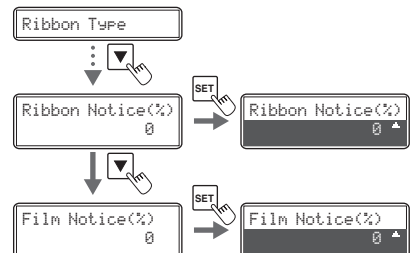

### 4 Change the settings by using the ▲/▼ Keys, then press the SET Key.

- The notification shows the remainder (%) at the time of notification.
- The remainder can be set to a figure from 0-20%. If the settings value is set to [0], then there will be no notification.
- Use the ▲/▼ Keys to change the value, and press the SET Key to fix the changes.
- If the MENU Key is pressed prior to pressing the SET Key to fix the changes, then the changes will be canceled.

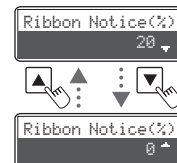

## 5 As time approaches for replacement of the Ink Ribbon or Transfer Film, a remaining quantity notification for these is displayed.

- In Normal Mode, if the Ink Ribbon and Transfer Film remaining quantity drops below the settings value (%), then the remaining quantity notification will appear at a set frequency (approximately 4 seconds).  
→See "Changing the Ink Ribbon and Transfer Film" on page 16 for details about changing the Ink Ribbon or Transfer Film.

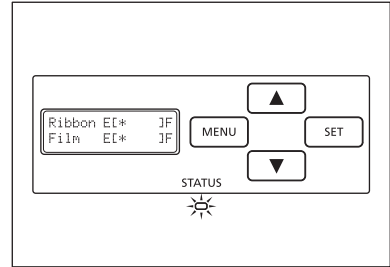

**Note**

- The factory default setting for [Ribbon Notice(%)] and [Film Notice(%)] is [0].

## Setting the Types of Card to Use

### ■ Adjusting the Feed Gate Depending on Card Thickness

Adjust the card case and the gate gap to match the fed cards.

#### 1 Open the top cover, and remove the Card Case.

- Hold the Card Case handle, and remove.

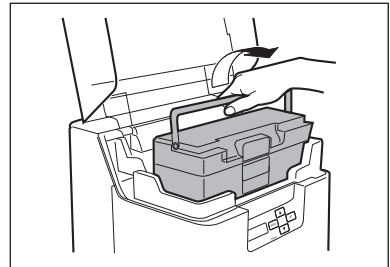

#### 2 Open the Card Case, and remove the cards from the cassette.

- Pull the lock, and open the Card Case cover.
- Pull the card retainer, and after removing the cards, return the card retainer to its original position.
- Remove the cards, and close the Card Case cover.

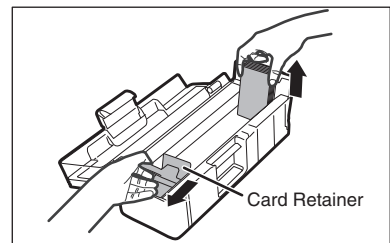

### 3 Rotate the dial on the lower surface of the Card Case and adjust the gate gap.

- The figures on the knob indicate the size of the gate gap.
- If cards do not pass through the gate, turn the knob to the right.
- If multiple cards pass through the gate, turn the knob to the left.

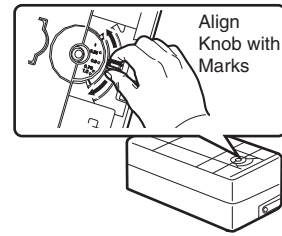

**Note**

- The factory default setting for the gate gap is [0.76 mm].

### 4 Close the Top Cover.

- Face the Card Case outwards, and after returning it to its original location, close the Top Cover.

## ■ Optimizing Transfer Conditions

Carry out secondary transfer under optimal conditions for the cards used.

**Note**

- You can also change the settings by using the printer driver (→See "Opening the Printer Driver Settings Screen" on page 87).

### 1 Switch from Normal Mode to User Mode.

→See "Switching to User Mode" on page 24 for details on how to switch to User Mode.

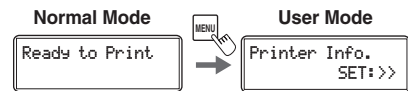

### 2 Press the ▼ Key until [Card Setup] is displayed, then press the SET Key.

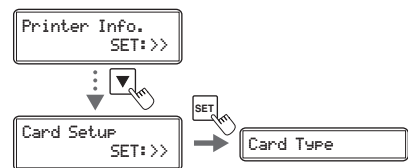

### 3 Confirm that [Card Type] appears, and press the SET Key.

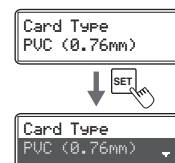

## 4 Change the settings by using the ▲/▼ Keys, then press the SET Key.

- Settings values that can be changed are as below.
- If CARD1-3 are selected, then go to Step 5. If other settings values are selected, then you have finished.

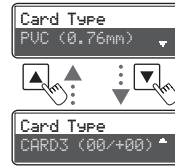

Settings Value	Details
PVC (0.76 mm)	Carry out secondary transfer using conditions corresponding to 0.76 mm thickness standard PVC card.
PET (0.76 mm)	Carry out secondary transfer using conditions corresponding to 0.76 mm thickness standard PET card.
PET-G (0.76 mm)	Carry out secondary transfer using conditions corresponding to 0.76 mm thickness standard PET-G card.
Sheet (PET)	Carry out secondary transfer using conditions corresponding to a 1.00 mm card with a PET sheet affixed to a PVC card.
CARD1 (XX,+XX) CARD2 (XX,+XX) CARD3 (XX,+XX)	Carry out secondary transfer using conditions set for values set for CARD 1-3. The left value is the transfer speed, and the right is the transfer temperature. Selecting either of these settings will then transition to transfer speed/transfer temperature settings. →See Step 5

**Note**

- The factory default setting is [PVC (0.76 mm)].

## 5 (Only if [CARD 1-3] are selected) Use the ▲/▼ Keys and the SET Key to set the transfer speed/transfer temperature.

- Use the ▲/▼ Keys to change the value, and press the SET Key to fix the changes.
- If the MENU Key is pressed prior to pressing the SET Key to fix the changes, then the changes will be canceled.
- The left value shows the transfer speed, and the right the transfer temperature.

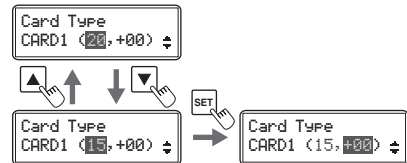

Settings Menu	Details
Transfer speed (left value)	Higher values mean a greater transfer speed, and lower values mean a lower transfer speed.
Transfer temperature (right value)	Higher values mean a greater temperature, and lower values mean a lower temperature.



## Correcting Card Curl

Depending on the cards you use, even given optimum secondary transfer conditions (speed and temperature), cards may curl. After secondary transfer, by correcting card curl (decurl), you can reduce the amount of curl.

### Note

- You can also change the settings by using the printer driver (→See "Opening the Printer Driver Settings Screen" on page 87).
- The factory default status is not to carry out decurl.
- Secondary transfer conditions (speed and temperature) that have not been optimized, and application of excess heat are major causes of cards curling after printing. Prior to correction using decurl, adjust the secondary transfer conditions.  
→See "Setting the Types of Card to Use" on page 42 for adjustment of secondary transfer conditions.

### 1 Switch from Normal Mode to User Mode.

→See "Switching to User Mode" on page 24 for details on how to switch to User Mode.

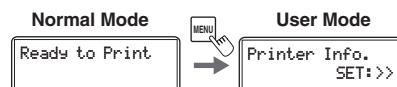

### 2 Press the ▼ Key until [Card Setup] is displayed, then press the SET Key.

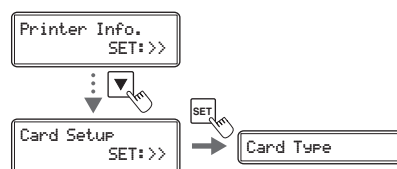

### 3 Press the ▼ Key until [Decurl Time(s)] is displayed, then press the SET Key.

- Cards that have had their warp corrected are output.

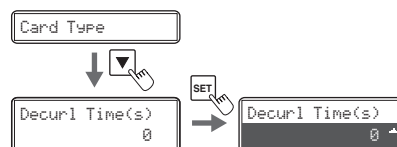

### 4 Change the settings by using the ▲/▼ Keys, then press the SET Key.

- Figures show the duration (seconds) for which decurl is carried out.
- You can set the decurl duration from 0-5 seconds. If the settings value is set to "0", then there will be no decurl.
- Use the ▲/▼ Keys to change the value, and press the SET Key to fix the changes.
- If the MENU Key is pressed prior to pressing the SET Key to fix the changes, then the changes will be canceled.

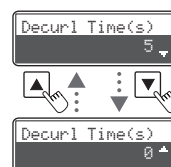

### Note

- The factory default setting is [0].

## Switching the Card Ejection Slot

You can switch the slot from which printed cards are output to Card Ejection Slot (Left) and (Right).  
 The factory default is set so that correctly printed cards are output from the Card Ejection Slot (Left), and cards with errors are output from Card Ejection Slot (Right).

**Note** • You can also change the settings by using the printer driver (→See "Opening the Printer Driver Settings Screen" on page 87).

**1 Switch from Normal Mode to User Mode.**  
 →See "Switching to User Mode" on page 24 for details on how to switch to User Mode.

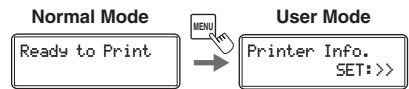

**2 Press the ▼ Key until [Card Setup] is displayed, then press the SET Key.**

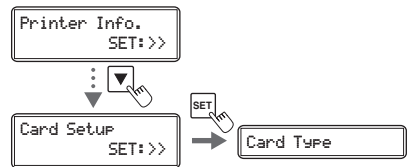

**3 After using the ▲/▼ Keys to switch between [Normal Exit]/[Error Exit], press the SET Key.**

- Select where to output correctly printed cards on the [Normal Exit] menu, and where to output abnormal cards on the [Error Exit] menu.

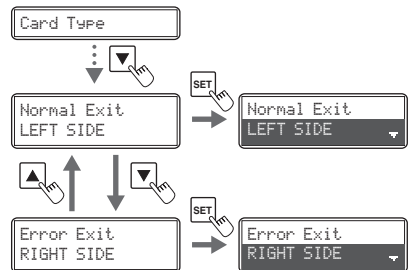

## 4 Change the settings by using the ▲/▼ Keys, then press the SET Key.

- Use the ▲/▼ Keys to switch between [LEFT SIDE]/[RIGHT SIDE].
- Set it to [LEFT SIDE] to output cards from Card Ejection Slot (Left), or [RIGHT SIDE] to do from Card Ejection Slot (Right).

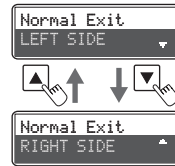

**Note**

- The Card Stacker can only be attached to the Card Ejection Slot (Left). Note that if the destination for normally printed cards is set to the Card Ejection Slot (Right), then output cards cannot be stacked.
- See the "Easy Setup Guide" for instructions on attaching the Card Stacker.

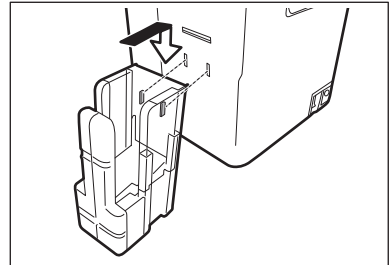

## Set the Orientation of Magnetic Cards/IC Cards to Load

Before loading magnetic card/IC cards, you need to set the Orientation of Magnetic Cards/IC Cards to Load.

→See "Loading Magnetic/IC Cards" on page 13 for how to set Magnetic Cards/IC Cards.

**Note**

- You can also change the settings by using the printer driver (→See "Opening the Printer Driver Settings Screen" on page 87).
- This setting is only available when the optional magnetic encoder unit is attached.

## 1 Switch from Normal Mode to User Mode.

→See "Switching to User Mode" on page 24 for details on how to switch to User Mode.

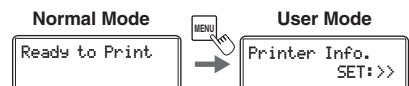

## 2 Press the ▼ Key until [Card Setup] is displayed, then press the SET Key.

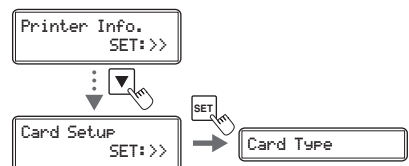

**3** Press the ▼ Key until [Set Face] is displayed, then press the SET Key.

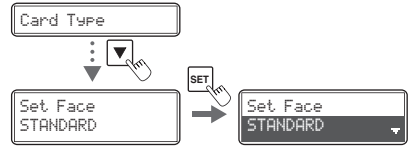

**4** Change the settings by using the ▲/▼ Keys, then press the SET Key.

- By combining printing sides of the card (front surface/ rear surface) and magnetic strips/IC cards, settings for loading can be changed as below.

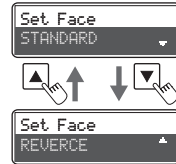

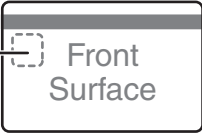
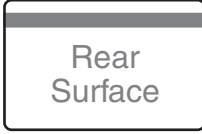
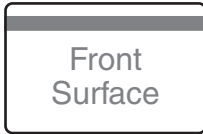
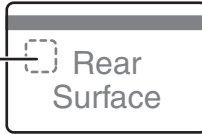
Settings Value	Card front surface (left surface)	Card rear surface (right surface)
STANDARD	<p>JIS2 magnetic strip/contact IC terminal</p> <p>Card Case Rear</p> <p>IC Terminal →  Front Surface</p> <p>Card Case Front</p>	<p>ISO magnetic strip</p> <p>Card Case Rear</p> <p> Rear Surface</p> <p>Card Case Front</p>
REVERSE	<p>ISO magnetic strip</p> <p>Card Case Rear</p> <p> Front Surface</p> <p>Card Case Front</p>	<p>JIS2 magnetic strip/contact IC terminal</p> <p>Card Case Rear</p> <p>IC Terminal →  Rear Surface</p> <p>Card Case Front</p>

**Note**

- The factory default setting is [STANDARD].

# Set the Orientation of Cards to Eject

Set the orientation of correctly printed cards.

- Note** • You can also change the settings by using the printer driver (→See "Opening the Printer Driver Settings Screen" on page 87).

**1 Switch from Normal Mode to User Mode.**  
 →See "Switching to User Mode" on page 24 for details on how to switch to User Mode.

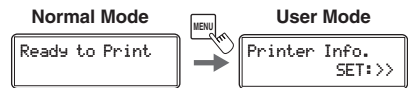

**2 Press the ▼ Key until [Card Setup] is displayed, then press the SET Key.**

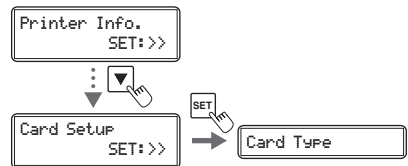

**3 Press the ▼ Key until [Eject Face] is displayed, then press the SET Key.**

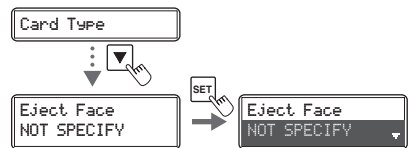

# 4 Change the settings by using the ▲/▼ Keys, then press the SET Key.

- Settings values that can be changed are as below.

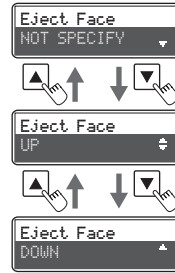

Settings Value	Details
NOT SPECIFY	The rear surface of cards to output cannot be set. Depending on the details of printing, the orientation that will print the most quickly is automatically selected. The front face of the card faces down for single-sided printing, and faces up for double-sided printing.
UP	The card is output with its front surface upwards.
DOWN	The card is output with its front surface downwards.

**Note**

- The factory default setting is [NOT SPECIFY].

## Changing Network Connection Settings

You can configure Internet communications settings such as the individual printer ID and TCP/IP-related settings.

### Note

- You can also change the settings by using the printer driver (→See "2. Print over a network" in "PrinterDriverManual(E).pdf" on the Printer Driver CD for network settings).

### 1 Switch from Normal Mode to User Mode.

→See "Switching to User Mode" on page 24 for details on how to switch to User Mode.



### 2 Press the ▼ Key until [Interface Setup] is displayed, then press the SET Key.

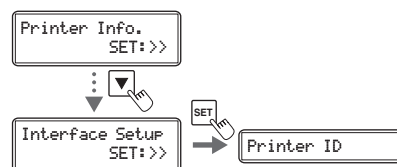

### 3 Select the setting to change by using the ▲/▼ Keys, then press the SET Key.

- Details of items that can be changed in each settings menu are as below.

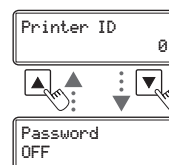

Settings Menu	Details
Printer ID	Set the individual printer ID (0-15).
DHCP	Set the DHCP function ON/OFF.
IP Address	Set the IP address. (Only when the DHCP function is OFF)
Subnet Mask	Set the subnet mask. (Only when the DHCP function is OFF)
Default Gateway	Displays the default gateway. (Only when the DHCP function is OFF)
MAC Address	Displays the MAC address.
IPsec	Set the IPsec function ON/OFF.
Timeout(s)	Set the session timeout (seconds).
Password	Set the password ON/OFF for setting TCP/IP using the printer driver. Additionally, if ON, then set the password.

## 4 Change the settings by using the ▲/▼ Keys, then press the SET Key.

- When setting numerical values, change each digit using the ▲/▼ Keys. Fix changes using the SET Key then progresses to the next digit. Pressing the SET Key after the final digit fixes the changes. If the MENU Key is pressed prior this, then the changes will be canceled.

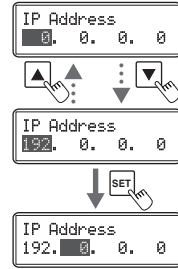

**Note**

- The factory default settings are [DHCP], [IPsec] and [Password] set to [OFF]. [Subnet Mask] and [Default Gateway] are set to [0.0.0.0]. [IP Address] is set to [169.254.0.0]. [Printer ID] is set to [8]. [Timeout(s)] is set to [30].
- [Interface Setup] settings can also be set when installing the network driver.
- Turn the power off and on to enable the settings.



## Preventing Theft and Unauthorized Usage

### ■ Preventing Theft of the Printer (Security Cable Slot)

You can prevent theft of the printer by locking it with a wire cable.

Use a wire cable that fits the Security Cable Slot (0.12" × 0.28" (3.00 mm × 7.00 mm)) to lock up the printer.

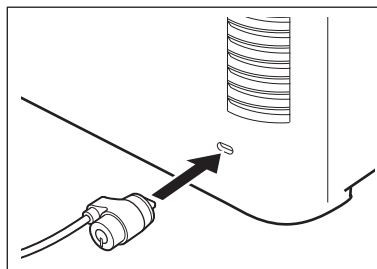

**Note**

- Use a commercial security cable.

### ■ How to Store Cards (Removing the Card Case)

You can prevent unauthorized use of the cards by removing the Card Case and locking it in a safe or other secure location.

#### 1 Open the top cover, and remove the Card Case.

- Hold the Card Case handle, and remove.

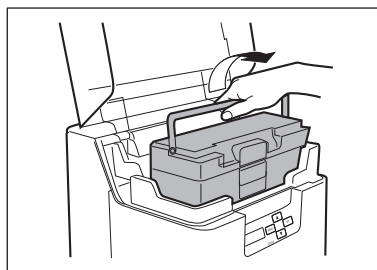

# Cleaning

The rollers need to be cleaned to maintain good print quality. This section explains which rollers need to be cleaned and how to clean them.

## Before Cleaning

Note the following cautions when cleaning the rollers.

- CAUTION** ● Remove any cards that are inside the printer.
- After cleaning the rollers, do not use the printer until the rollers get dry (for at least five minutes).
- Do not touch the rollers with your bare hands.

## Cleaning with a Cleaning Card

Use the Cleaning Card (provided) to clean the Card Transport Roller if cards do not feed smoothly.

We recommend cleaning the rollers after printing about 1,000 cards.

→See "Cleaning Card" on page 82 for details about which Cleaning Cards you can use.

- 
- Note** ● The [Card Count] and [Total Count] functions make it easy to keep track of how many cards are printed.
    - See "Counting the Number of Cards that Are Printed" on page 27 for details of the [Card Count] function.
    - See "Displaying the Total Number of Sides that Are Printed" on page 28 for details of the [Total Count] function.

- CAUTION** ● Cleaning Cards can only be used once and cannot be reused. Use a new Cleaning Card with the adhesive side down every time you clean the rollers.

## 1 Switch from Normal Mode to User Mode.

→See "Switching to User Mode" on page 24 for details on how to switch to User Mode.

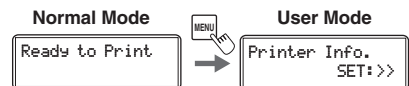

- 2** Press the ▼ Key until [Cleaning] is displayed, then press the SET Key.

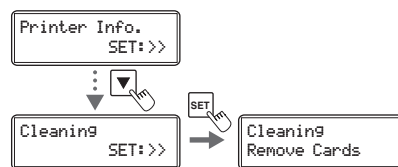

- 3** When [Cool Down ---] is displayed, wait until the figure drops to 70 or lower.

- This figure indicates the temperature of the heat roller.
- If the heat roller is hot, then it may take 20 minutes for the temperature to drop to 70 or below.



- 4** When [Remove Film] is displayed, open the Front Cover, and remove the Transfer Film.

→See "Transfer Film Replacement" on page 19 for details on how to remove the Transfer Film.

- When the Transfer Film has been removed, close the Front Cover.

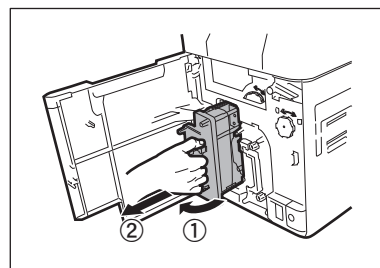

- 5** When [Remove Cards] is displayed, open the Top Cover.

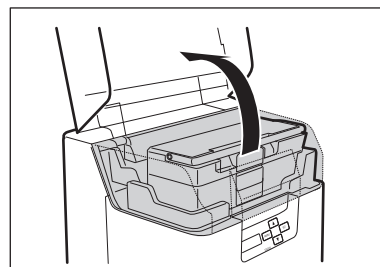

- 6** Open the Card Case, and remove the cards from the cassette.

- Pull the lock, and open the Card Case lid.
- Pull the card retainer, and after removing the cards, return the card retainer to its original position.

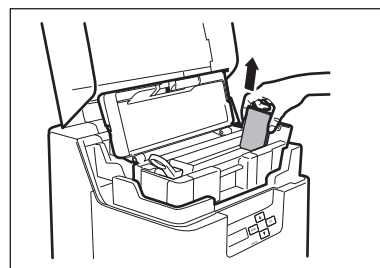

## Full Color Card Printer

### 7 When [Set Cleaning Crd] is displayed, load the Cleaning Card in the Card Feeding Slot.

- When the Cleaning Card is loaded, close the Card Case cover and the Top Cover.
- Align the adhesive side of the Cleaning Card to the right.

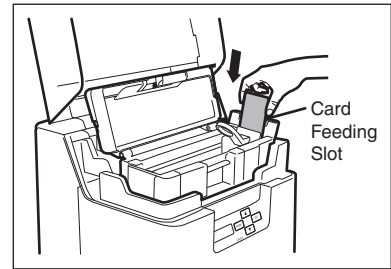

### 8 When [SET:Start] is displayed, press the SET Key.

- The Cleaning Card is pulled into the printer and cleaning starts.
- The Cleaning Card comes out of the Card Ejection Slot (Left) when cleaning is completed.
- When [Finish] is displayed, cleaning is completed.

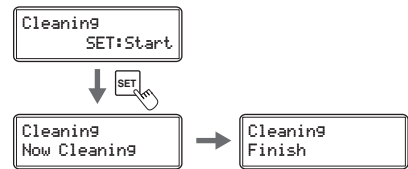

## Cleaning the Cleaning Roller

Clean the Cleaning Roller if cards are printed with missing colors or if there are foreign objects on them.

- 
- CAUTION**
- Be sure to turn off the printer before cleaning the rollers.
  - Read the cautions in "Before Cleaning" on page 54.

**1 Turn off the power.**

**2 Open the Front Cover.**

- Press the open over switch, and pull the Front Cover forward.

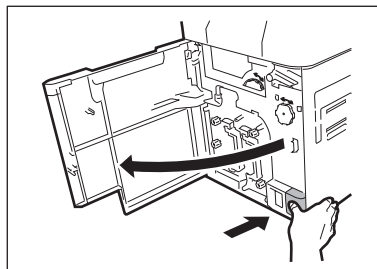

**3 Remove the Cleaning Tape Cassette.**

- Hold the Cleaning Tape Cassette handle with your fingers, raise it slightly, and pull it out.

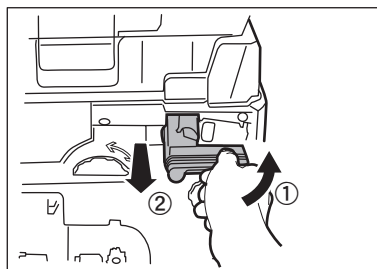

**4 Remove the Cleaning Roller.**

- Hold the Cleaning Roller handle on the right of the Cleaning Tape Cassette, and pull it out.

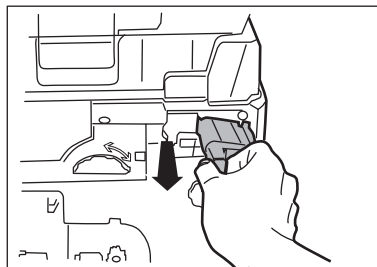

## Full Color Card Printer

### 5 Wipe the roller clean.

- Use a soft cloth fully moistened with **water** and wrung out to wipe the roller clean.

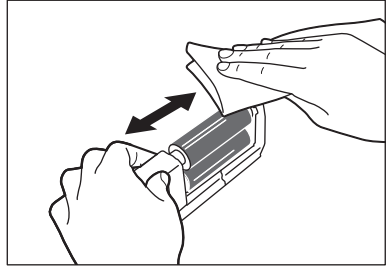

### 6 Load the Cleaning Roller and Cleaning Tape Cassette in order, and close the Front Cover.

## Cleaning the Feeding Roller

Clean the Feeding Roller under the Card Case if cards do not feed smoothly into the printer.

- CAUTION**
- Be sure to turn off the printer before cleaning the rollers.
  - Read the cautions in "Before Cleaning" on page 54.

**1 Turn off the power.**

**2 Open the top cover, and remove the Card Case.**

- Hold the Card Case handle, and remove.

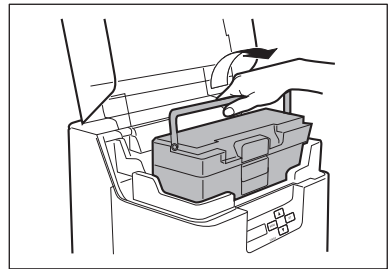

**3 Wipe the roller clean.**

- Use a soft cloth fully moistened with **water** and wrung out to wipe the roller clean.
- Turn the roller as you wipe it to clean it in the direction of an arrow.

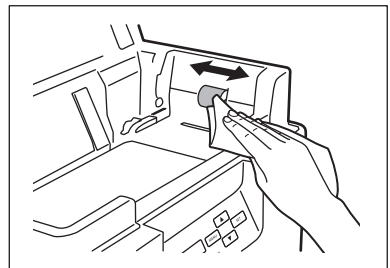

**4 Load the Card Case.**

- Return the Card Case to its original position.

**5 Close the Top Cover.**

## Cleaning the Feeding Roller

If the printing location on printed cards is out of adjustment, or there is white space at the edge of printed areas, then clean the secondary transfer section feeding roller at the bottom of the top cover.

- CAUTION**
- Be sure to turn off the printer before cleaning the rollers.
  - Read the cautions in "Before Cleaning" on page 54.

**1 Turn off the power.**

**2 Open the top cover, and remove the Card Case.**

- Hold the Card Case handle, and remove.

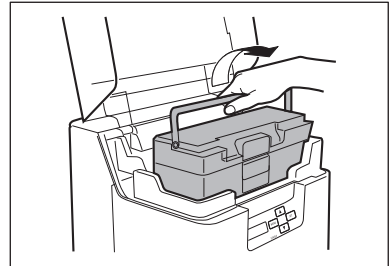

**3 Open the Front Cover and Top Cover.**

- Press the open over switch, and pull the Front Cover forward.
- Hold the handle of the Top Cover and lift to open.
- If you do not open the Front Cover, then you cannot open the Top Cover.

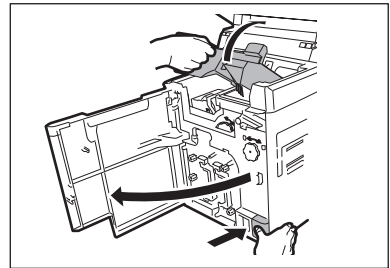

**4 Lift the decurl section.**

- First release the lock on the decurl section as at right before lifting.

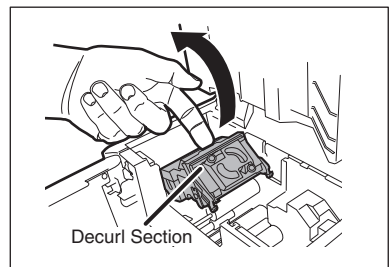



## 5

### Wipe the roller clean.

- Use a soft cloth fully moistened with **water** and wrung out to wipe the roller clean.
- As you turn the card feeding knob, fully clean the roller.
- Clean the card feeding roller (5 locations).

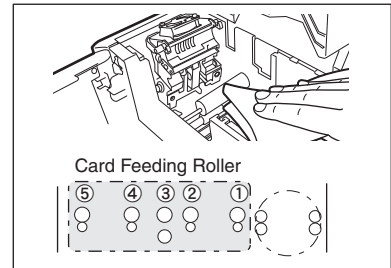

- CAUTION**
- It is difficult to reach the bottom part of the decurl section (output side) rollers, and cleaning can be troublesome. Be careful to not hurt your fingers.
  - The bottom part of location ③ in the figure above is the heat roller, and is therefore hot. Please exercise care when cleaning.

## 6

### Close the Top Cover and Front Cover.

- Before closing the cover, return the Card Case and decurl section to their original positions.

## Cleaning the Reverse Roller

If card delivery from the reverse section to the secondary transfer feeding roller is not possible, then clean the Reverse Roller.

- CAUTION**
- Be sure to turn off the printer before cleaning the rollers.
  - Read the cautions in "Before Cleaning" on page 54.

**1 Turn off the power.**

**2 Open the top cover, and remove the Card Case.**

- Hold the Card Case handle, and remove.

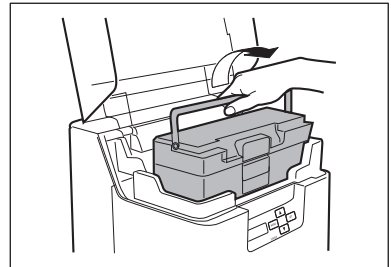

**3 Open the Front Cover and Top Cover.**

- Press the open over switch, and pull the Front Cover forward.
- Hold the handle of the Top Cover and lift to open.
- If you do not open the Front Cover, then you cannot open the Top Cover.

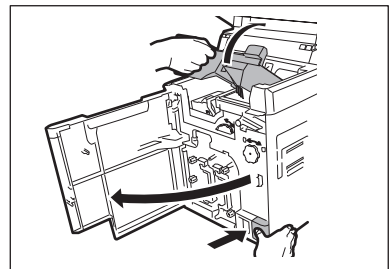

**4 Rotate the reverse knob, and locate the reverse section roller as in the diagram.**

- When checking inside the reverse section, remove the Cleaning Roller and Cleaning Tape Cassette.  
→See "Cleaning Tape Replacement" on page 22 and "Cleaning the Cleaning Roller" on page 57 for instructions on removing the Cleaning Roller and Cleaning Tape Cassette.

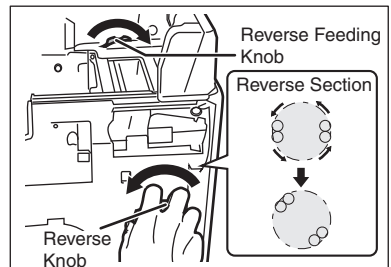

## 5

### Wipe the roller clean.

- Use a soft cloth fully moistened with **water** and wrung out to wipe the roller clean.
- Rotate the reverse feeding knob, and fully clean the roller.
- Turn the reverse knob to rotate the reverse section one turn, and clean the other side of the Reverse Roller.

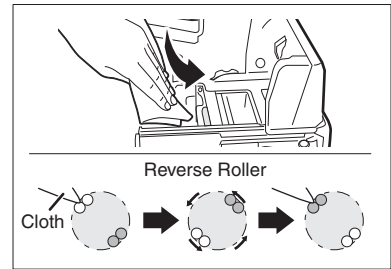

## 6

### Close the Top Cover and Front Cover.

- Before closing the cover, return the Card Case, decurl section, Cleaning Roller, and Cleaning Tape Cassette to their original positions.

## Primary Transfer Feeding Roller Cleaning

If a film-related error occurs such as [Film Wind up], or there is color bleed or image distortion, then clean the primary transfer feeding roller.

- CAUTION**
- Be sure to turn off the printer before cleaning the rollers.
  - Read the cautions in "Before Cleaning" on page 54.

**1 Turn off the power.**

**2 Open the top cover, and remove the Card Case.**

- Hold the Card Case handle, and remove.

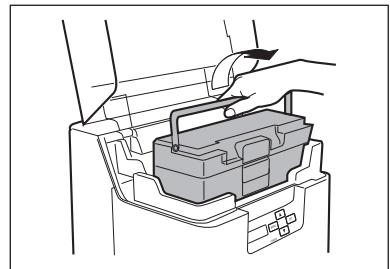

**3 Open the Front Cover.**

- Press the open over switch, and pull the Front Cover forward.

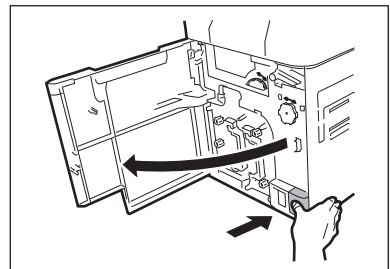

**4 Remove the Ink Ribbon Cassette and the Transfer Film.**

- See "Changing the Ink Ribbon and Transfer Film" on page 16 for details on how to remove the Ink Ribbon Cassette and Transfer Film.

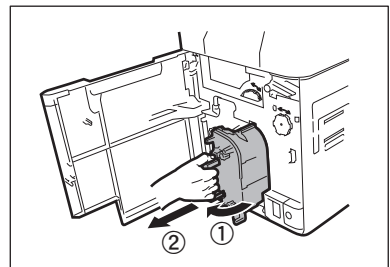

## 5 Insert a flat screwdriver or coin into the groove on the end of the feeding roller.

- Ensure you have a flat screwdriver or coin that can fit into the groove on the end of the feeding roller.

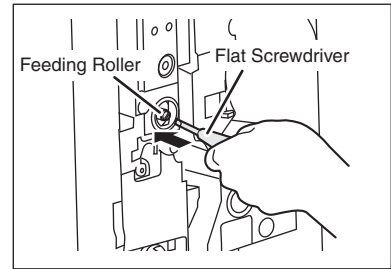

## 6 Wipe the roller clean.

- Turn the screwdriver (or coin), and wipe the feeding roller using a cotton swab with a long handle fully moistened with water.

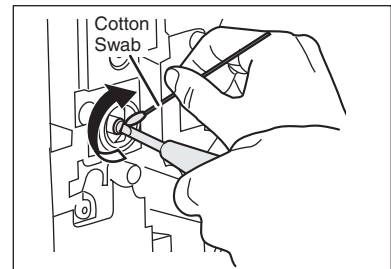

## 7 Return the Ink Ribbon Cassette and the Transfer Film Cassette to their original positions.

→See "Changing the Ink Ribbon and Transfer Film" on page 16 for details about attaching the Ink Ribbon and Transfer Film.

## 8 Close the Front Cover.

## Filter Cleaning

If the filter becomes clogged, then dirt may enter the printer. It is recommended that the filter be cleaned monthly.

- 
- CAUTION**
- Be sure to turn off the printer before cleaning the rollers.
  - Read the cautions in "Before Cleaning" on page 54.

**1 Turn off the power.**

**2 Remove the filter cover on the rear of the printer.**

- Hold the handle with your fingers, and pull.

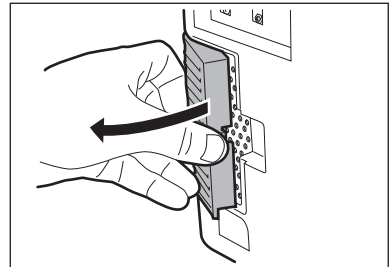

**3 Use a vacuum cleaner or similar to remove dirt that is adhered to the filter.**

- Remove the filter from the filter cover.
- Hold the filter down with your fingers in order that it is not sucked into the vacuum cleaner.

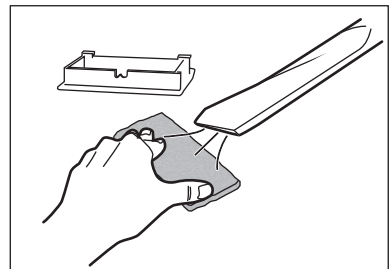

**4 Attach the filter cover to the printer.**

- Attach the filter to the filter cover.

# Troubleshooting

This section explains what to do when an error message appears, a card is jammed, or there is a problem with the printed side of a card.

## When an Error Message Appears

The LED Indicator is lit orange or blinks, and a description of the error appears on the LCD Panel when an error occurs.

### ■ Clearing an Error

Follow the instructions below to clear an error.

After clearing an error, pressing the SET Key will initialize the printer, [Ready to Print] will appear, and the printer will return to normal status.

**Note**

- When two errors occur, only the first error message is displayed. Pressing the SET Key after clearing the first error displays the next error. Continue to clear errors until [Ready to Print] appears.

### ■ How to Clear an Error

Resolve error messages that appear on the LCD Panel according to the instructions below.

Error message	Cause and solution
Cover is Open	<b>The Front Cover is open.</b> ⇒Make sure the Front Cover is closed.
Card Empty	<b>There are no more cards.</b> ⇒Load cards into the printer. →See "Loading Cards" on page 10 for instructions on loading cards.
Low Temperature	<b>The temperature in which the printer is located is too low.</b> ⇒Ensure the environment temperature is 10°C or higher, and press the SET Key.

**Full Color Card Printer**

Error message	Cause and solution
Ribbon Empty	<p><b>The Ink Ribbon has been used up.</b>            ⇒Replace the Ink Ribbon.            →See "Changing the Ink Ribbon and Transfer Film" on page 16 for details about changing the Ink Ribbon.</p>
Ribbon Type	<p><b>The Ink Ribbon could not be detected correctly.</b>            ⇒Reload the Ink Ribbon.            →See "Changing the Ink Ribbon and Transfer Film" on page 16 for details about changing the Ink Ribbon.            ⇒<b>The Ink Ribbon set in the printer and printer settings may be different.</b>            →See "Ink Ribbon/Transfer Film" on page 81 about the supported types of Ink Ribbon.            →See "Setting the Type of Ink Ribbon or Transfer Film to Use" on page 39 for details on how to set the Ink Ribbon type.            ⇒<b>Ink Ribbons not supported by this printer cannot be used.</b>            →See "Ink Ribbon/Transfer Film" on page 81 for details about supported Ink Ribbon.</p>
Ribbon Wind up	<p><b>The Ink Ribbon could not be wound correctly.</b>            ⇒Reload the Ink Ribbon.            →See "Changing the Ink Ribbon and Transfer Film" on page 16 for details about changing the Ink Ribbon.</p> <p><b>The Ink Ribbon may be cut.</b>            ⇒Repair the cut Ink Ribbon.            →See "If the Ink Ribbon or Transfer Film are Cut" on page 76 for instructions on how to repair a cut Ink Ribbon.            ⇒<b>The Ink Ribbon set in the printer and printer settings may be different.</b>            →See "Ink Ribbon/Transfer Film" on page 81 about the supported types of Ink Ribbon.            →See "Setting the Type of Ink Ribbon or Transfer Film to Use" on page 39 for details on how to set the Ink Ribbon type.</p>
Film Empty	<p><b>The Transfer Film has been used up.</b>            ⇒Replace the Transfer Film.            →See "Changing the Ink Ribbon and Transfer Film" on page 16 for details about changing the Transfer Film.</p>



**Error message**

**Cause and solution**

<p>Film Type</p>	<p><b>The Transfer Film could not be detected correctly.</b>          ⇒Reload the Transfer Film.          →See "Changing the Ink Ribbon and Transfer Film" on page 16 for details about changing the Transfer Film.          ⇒The Transfer Film set in the printer and printer settings may be different.          →See "Ink Ribbon/Transfer Film" on page 81 about the supported types of Transfer Film.          →See "Setting the Type of Ink Ribbon or Transfer Film to Use" on page 39 for details on how to set the Transfer Film type.          ⇒Transfer Film not supported by this printer cannot be used.          →See "Ink Ribbon/Transfer Film" on page 81 for types of supported Transfer Film.</p>
<p>Film Wind up</p>	<p><b>The Transfer Film could not be wound up.</b>          ⇒Reload the Transfer Film.          →See "Changing the Ink Ribbon and Transfer Film" on page 16 for details about changing the Transfer Film.</p> <p><b>The Transfer Film may be cut.</b>          ⇒Repair the cut Transfer Film.          →See "If the Ink Ribbon or Transfer Film are Cut" on page 76 for instructions on how to repair a cut Transfer Film.          ⇒The Transfer Film set in the printer and printer settings may be different.          →See "Ink Ribbon/Transfer Film" on page 81 about the supported types of Transfer Film.          →See "Setting the Type of Ink Ribbon or Transfer Film to Use" on page 39 for details on how to set the Transfer Film type.</p>
<p>Rbn &amp; Film Empty</p>	<p><b>Both the Ink Ribbon and Transfer Film have been used up.</b>          ⇒Replace both the Ink Ribbon and the Transfer Film.          →See "Changing the Ink Ribbon and Transfer Film" on page 16 for details about changing the Ink Ribbon and Transfer Film.</p>

Error message	Cause and solution
<div data-bbox="129 222 427 288" style="border: 1px solid black; border-radius: 10px; padding: 5px; text-align: center;">Card Jam Feeder</div>	<p><b>Cards cannot be fed into printer.</b> ⇒ Press the SET Key.</p> <p><b>Frequent occurrences of this error may mean the following:</b></p> <p><b>Is the Card Case loaded correctly?</b> ⇒ Correctly load the Card Case. ⇒ Confirm that the Card Case card retainer is loaded properly. → See "Loading Cards" on page 10 for instructions on loading cards.</p> <p><b>Is the Feeding Roller dirty?</b> ⇒ Clean the Feeding Roller located below the Card Case. → See "Cleaning the Feeding Roller" on page 59 for Feeding Roller cleaning instructions.</p>
<div data-bbox="129 644 427 710" style="border: 1px solid black; border-radius: 10px; padding: 5px; text-align: center;">Card Jam F.Turn</div> <div data-bbox="129 748 427 814" style="border: 1px solid black; border-radius: 10px; padding: 5px; text-align: center;">Card Jam Print</div> <div data-bbox="129 852 427 918" style="border: 1px solid black; border-radius: 10px; padding: 5px; text-align: center;">Card Jam M9</div>	<p><b>There was a card jam.</b> ⇒ Press the SET Key.</p> <p><b>An error occurred, and cards cannot be output.</b> ⇒ Remove the cards by rotating the Ejection Dial, and press the SET Key. → See "When a Card is Jammed..." on page 73 for instructions on how to remove cards.</p> <p><b>Frequent card jams could mean the following:</b></p> <p><b>Is the Feeding Roller dirty?</b> ⇒ Clean the Feeding Roller. ⇒ If the Feeding Roller is excessively dirty, continue cleaning using a new Cleaning Card. → See "Cleaning with a Cleaning Card" on page 54 for instructions on cleaning the Feeding Roller.</p>
<div data-bbox="129 1152 427 1218" style="border: 1px solid black; border-radius: 10px; padding: 5px; text-align: center;">Card Feed Remove</div> <div data-bbox="129 1256 427 1322" style="border: 1px solid black; border-radius: 10px; padding: 5px; text-align: center;">Card Turn Remove</div> <div data-bbox="129 1361 427 1426" style="border: 1px solid black; border-radius: 10px; padding: 5px; text-align: center;">Card Pr Remove</div> <div data-bbox="129 1465 427 1531" style="border: 1px solid black; border-radius: 10px; padding: 5px; text-align: center;">Card M9 Remove</div>	<p><b>There was a card jam.</b> ⇒ Remove the cards by rotating the Ejection Dial, and press the SET Key. → See "When a Card is Jammed..." on page 73 for instructions on how to remove cards.</p> <p><b>Frequent card jams could mean the following:</b></p> <p><b>Is the Feeding Roller dirty?</b> ⇒ Clean the Feeding Roller. ⇒ If the Feeding Roller is excessively dirty, continue cleaning using a new Cleaning Card. → See "Cleaning with a Cleaning Card" on page 54 for instructions on cleaning the Feeding Roller.</p>

Error message	Cause and solution
Service Call	<p><b>An error that requires repair may occur.</b></p> <p><b>The cause of the error differs depending on the error code.</b>            ⇒ Turn off and on the power.            Repairs are necessary if the error reoccurs.</p>
Download Error	<p><b>Program version update was interrupted.</b>            ⇒ Turn off and on the power, then start version update again.</p>
Mg Write Error	<p><b>Reading/writing of the magnetic data failed.</b>            ⇒ Press the SET Key.</p>
Mg Read Error	<p><b>Failure when reading/writing the magnetic data may mean the following:</b></p> <p><b>Is the card set in the correct direction?</b>            ⇒ Check the loading direction of the cards.            → See "Loading Cards" on page 10 for instructions on loading cards.</p> <p><b>Are there any scratches or dirt on the card's magnetic strip?</b>            ⇒ Use undamaged cards.</p> <p><b>Do the magnetic characteristics of the card match the specifications of the magnetic encoder and the settings of the magnetic encoder?</b>            ⇒ Check the specifications of the magnetic encoder.            → See "Checking the Program Version and Serial Number" on page 30 for instructions on how to check the specifications of the magnetic encoder.</p>
IC1 Access Error	<p><b>During operation of the IC option 1, data reception by the computer was interrupted.</b>            ⇒ Press the SET Key.            → Follow the directions of the application printing cards.</p>
IC2 Access Error	<p><b>During operation of the IC option 2, data reception by the computer was interrupted.</b>            ⇒ Press the SET Key.            → Follow the directions of the application printing cards.</p>
External Box	<p><b>During operation of the external box, data reception by the computer was interrupted.</b>            ⇒ Press the SET Key.            → Follow the directions of the application printing cards.</p>

After clearing an error, pressing the SET Key clears the errors, initializes the printer, and [Ready to Print] will appear.

## Full Color Card Printer

If the following messages appear after pressing the SET key, resolve the problem according to the instructions below.

Message	Solution
Push SET key	Press the SET Key.
Card Empty	Load the card in the Card Case.
Cover is Open	Correctly close the cover.
Low Temperature	Ensure the environment temperature is 10°C or higher, and press the SET Key.
Check Ribn/Film	Confirm that the Ink Ribbon and Transfer Film are correctly loaded. If these are used up, then replace the Ink Ribbon or Transfer Film. →See "Changing the Ink Ribbon and Transfer Film" on page 16 for details about changing the Ink Ribbon or Transfer Film.
Remove Cards	Remove the cards by rotating the Ejection Dial. →See "When a Card is Jammed..." on page 73 for instructions on how to remove cards.

## When a Card is Jammed...

Use the following procedure to remove cards jammed during printing or when the jammed card is unable to be removed despite the SET Key being pressed. Ejection Dials are at 3 locations within the printer.



- Cards being printed are transported through this printer using the following path.  
If cards are not correctly output, then there may be a jam in any of the following locations.

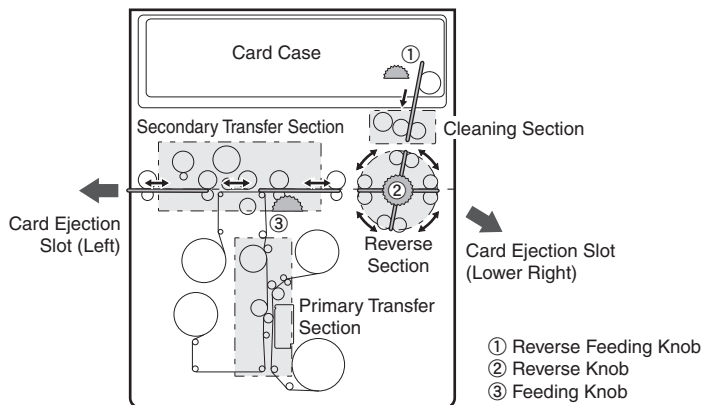

### 1 (If cards are jammed within the Card Case) Remove cards from the Card Case.

- If the furthest-right card is partially fed into the machine, slowly pull it out by hand.
- If the jam is cleared, then go to Step 8.

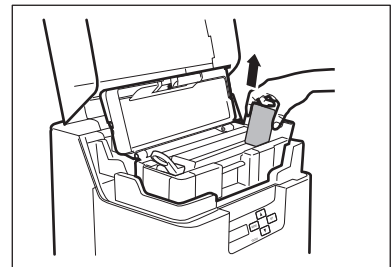

### 2 Remove the Card Case.

- Close the Card Case cover, hold the handle, and remove.

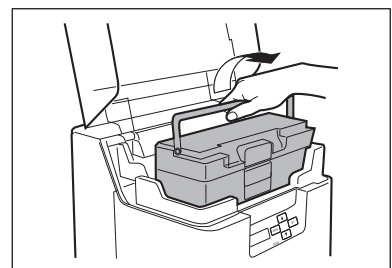

## Full Color Card Printer

### 3 (If cards can be seen in the feed slot) Rotate the reverse feeding knob.

- Remove cards jammed in the cleaning section from the feed slot.
- Cards jammed in the reverse section can also be output.
- If the jam is cleared, then go to Step 8.

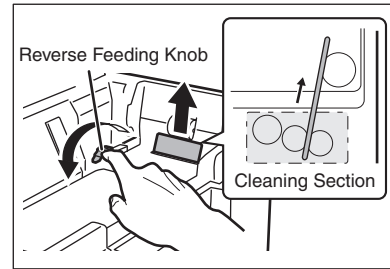

### 4 Open the Front Cover and Top Cover.

- Press the open over switch, and pull the Front Cover forward.
- Hold the handle of the Top Cover and lift to open.
- If you do not open the Front Cover, then you cannot open the Top Cover.

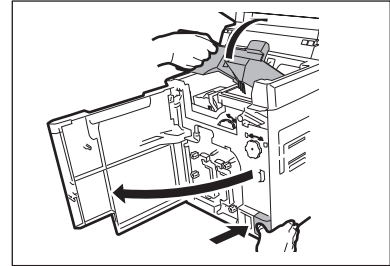

### 5 Confirm the location of jammed cards.

- To confirm the interior of the decurl section, first release the lock on the decurl section as at right before lifting.
- When checking inside the reverse section, remove the Cleaning Roller and Cleaning Tape Cassette. →See "Cleaning Tape Replacement" on page 22 and "Cleaning the Cleaning Roller" on page 57 for instructions on removing the Cleaning Roller and Cleaning Tape Cassette.

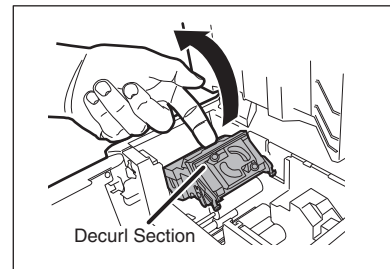

### 6 (If the card is in the reverse section)

#### ① Rotate the reverse knob so that the cards are parallel, and rotate the feeding knob left and right.

- If the feeding knob is rotated to the left, then jammed cards are output from the Card Ejection Slot (Left), and if this is rotated to the right, then these are output from Card Ejection Slot (Right).

#### ② Rotate the reverse knob so that the edge of the cards is at the upper left, and rotate the reverse feeding knob so that this outputs as in the figure at right.

- Jammed cards will be output from the top of the printer, so remove these by hand.
- If the jam is cleared, then go to Step 8.

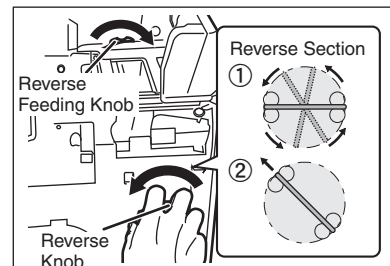

## 7 (If the card is in other than the reverse section)

### Rotate the feeding knob.

- Jammed cards are ejected from Card Ejection Slot (left).
- If the jam is cleared, then go to Step 8.

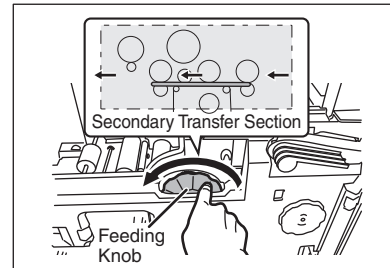

## 8 Close the Top Cover and Front Cover.

- Before closing the cover, return the Card Case, decurl section, Cleaning Roller, and Cleaning Tape Cassette to their original positions.

## 9 Press the SET Key.

- The error message on the LCD Panel disappears, and the printer returns to Normal Mode.

## If the Ink Ribbon or Transfer Film are Cut

If the Ink Ribbon or Transfer Film are cut for any reason, then repair these using the method below.

### 1 Remove the Ink Ribbon Cassette or Transfer Film Cassette.

→See "Changing the Ink Ribbon and Transfer Film" on page 16 for details on how to remove the Ink Ribbon Cassette and Transfer Film Cassette.

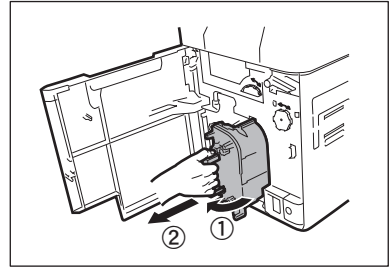

### 2 Carefully trim the cut section with scissors.

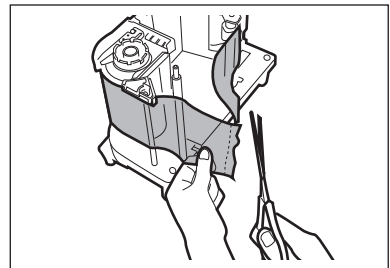

### 3 Use cellophane tape to join the ribbon or film.

- Place the cut area in the middle.
- Join the cut surfaces so that they are aligned properly.
- Do not discard the used ink or film on the winding side.

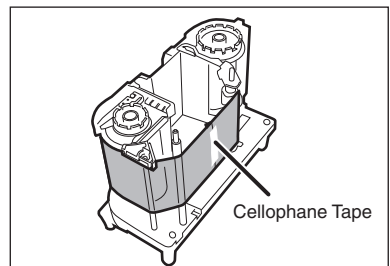



## 4 Rotate the winding side knob.

- Rotate the knob until the joined section of the Ink Ribbon or Transfer Film is fully inside the winding side spool spindle.

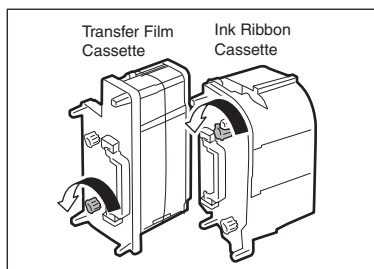

## 5 Return the Ink Ribbon Cassette or Transfer Film Cassette to their original positions.

→See "Changing the Ink Ribbon and Transfer Film" on page 16 for details about attaching the Ink Ribbon and Transfer Film.





## 6 Close the Front Cover.

## 7 Press the SET Key.

- The error message on the LCD Panel disappears, and the printer returns to Normal Mode.

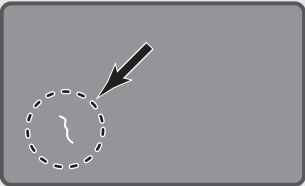

## When Cards are Not Printed Correctly...

If missing or incorrect colors are printed on a card or cards are incorrectly printed, resolve the problem according to the following instructions.

Problem	Cause and solution
<p>There are missing or incorrect colors in certain sections. Dirt is present.</p> 	<p><b>Is there dirt on the card surface?</b>                      ⇒Do not use dirty cards.                      ⇒Avoid using the printer in locations with excessive dust or dirt.</p> <p>⇒Clean the Cleaning Roller.                      →See "Cleaning the Cleaning Roller" on page 57 for cleaning instructions.</p> <p>⇒Use a Cleaning Card to clean the Cleaning Roller.                      →See "Cleaning with a Cleaning Card" on page 54 for instructions on how to clean with a cleaning card.</p>
<p>There is an unprinted area on the left of the card.</p> 	<p><b>Is there dirt on the Feeding Roller?</b>                      ⇒Use a Cleaning Card to clean the Cleaning Roller.                      →See "Cleaning with a Cleaning Card" on page 54 for instructions on how to clean with a cleaning card.</p> <p>⇒Clean the Feeding Roller.                      →See "Cleaning the Feeding Roller" on page 60 for instructions on cleaning the Feeding Roller.</p>
<p>The card is bent.</p> 	<p><b>Secondary transfer conditions (speed and temperature) are not optimum.</b>                      ⇒Set secondary transfer conditions in accordance with cards used.                      →See "Setting the Types of Card to Use" on page 42 for instructions on setting secondary transfer conditions.</p>
<p>Print flakes off.</p> 	<p><b>Secondary transfer conditions (speed and temperature) are not optimum.</b>                      ⇒Set secondary transfer conditions in accordance with cards used.                      →See "Setting the Types of Card to Use" on page 42 for instructions on setting secondary transfer conditions.</p>

**Problem**

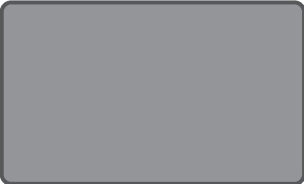
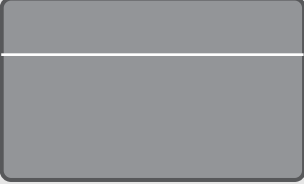
**Cause and solution**

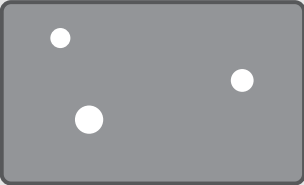
<p>White cards (unprinted cards) are output.</p> 	<p><b>Only color image data was received with the Black Ink Ribbon loaded.</b>          ⇒Use the Overcoating Color Ink Ribbon when printing in color.          →See "Changing the Ink Ribbon and Transfer Film" on page 16 for details about changing the Ink Ribbon.</p> <p><b>Secondary transfer conditions (speed and temperature) are not optimum.</b>          ⇒Set secondary transfer conditions in accordance with cards used.          →See "Setting the Types of Card to Use" on page 42 for instructions on setting secondary transfer conditions.</p>
<p>General Print Problems (Incorrect Colors, etc.)</p> 	<p><b>The Ink Ribbon type setting is different.</b>          ⇒Set the printer according to the type of Ink Ribbon used.          →See "Setting the Type of Ink Ribbon or Transfer Film to Use" on page 39 for details on how to set the Ink Ribbon type.</p>
<p>Fine lines are not printed.</p> 	<p><b>Contact your reseller.</b></p>
<p>There is a surface irregularity.</p> 	<p><b>Contact your reseller.</b></p>
<p>There are partial white areas.</p> 	<p><b>Contact your reseller.</b></p>

## Full Color Card Printer

Problem	Cause and solution
<p>Some or all of the printed area are cloudy.</p>	<p><b>Is the Transfer Film running between the two pins on top of the Transfer Film Cassette?</b>            ⇒Make sure that the Transfer Film is correctly loaded.            →See "Transfer Film Replacement" on page 19 on how to install the Transfer Film.</p> <p><b>Is the pin on top of the Transfer Film Cassette attached correctly?</b>            ⇒Make sure that the pin on top of the Transfer Film Cassette is attached correctly.            →See "Transfer Film Replacement" on page 19 on how to attach the pin on top of the Transfer Film Cassette.</p> <p><b>Secondary transfer conditions (speed and temperature) are not optimum.</b>            ⇒Set secondary transfer conditions in accordance with cards used.            →See "Setting the Types of Card to Use" on page 42 for instructions on setting secondary transfer conditions.</p>

## Other Troubles

Problem	Solution
<p>The power cannot be turned on.</p>	<p>Make sure the power cable is connected.</p>
<p>Data cannot be sent to the printer.</p>	<p>Make sure the USB cable is connected.            Make sure the network is connected.</p>
<p>The printer cannot connect to the network.</p>	<p>Confirm User Mode network settings.            ⇒See "Changing Network Connection Settings" on page 51 for how to confirm network settings.</p>

## When These Solutions Don't Work...

Contact your reseller if errors appear which are not included in this manual or when an error cannot be cleared.

- Note**
- When contacting your reseller, provide them with the content of the message and the error code (XX-XX) that appears on the right side of the LCD Panel.



# Appendix

## Consumables

### ■ Ink Ribbon/Transfer Film

The 2 types of Ink Ribbon that can be used in this printer are as follows.

Name	Type	Product no	Number of Printable Sides	Remarks
Retransfer Color Ink Ribbon	R-YMCK	PR5002-R4C	500 screens/spool	—
Retransfer Reverse Overcoating Color Ink Ribbon	R-YMCKK	PR5002-R5K	400 screens/spool	—

Transfer Film (transparent type) that can be used with this printer is one type only.

Name	Type	Product no	Number of Printable Sides	Remarks
Retransfer Film	R-InTM1	PR5002-RI1	500 screens/spool	With Cleaning Tape

If using other Ink Ribbon/Transfer Film, please contact your reseller.

- 
- ⚠ CAUTION**
- Directly touching the Ink Ribbon/Transfer Film may cause uneven print density.
  - When changing the Ink Ribbon/Transfer Film, do not subject these to excessive impacts.
  - Use of non-genuine parts may lead to reduced print quality, or printer malfunctions.
  - We cannot guarantee the quality and reliability of non-genuine products.
  - Repair of faults caused by the use of non-genuine products shall be charged, even if the printer is within the warranty period.

- Note**
- The number of printable sides may decrease under the following conditions.
    - Changing the Ink Ribbon/Transfer Film during use
    - When an error occurs during printing
    - Performing operations not listed in this manual
  - Use Ink Ribbon/Transfer Film as soon as possible after purchase.
  - When storing Ink Ribbon/Transfer Film, avoid locations that are exposed to direct sunlight, high temperatures, or with excessive dust or dirt.

## Full Color Card Printer

### ■ Cards

Use only cards that conform to the CR-80 standard.

Size: 3.4" × 2.1" (86 mm × 54 mm) Thickness: 0.03"-0.04" (0.76 mm-1.00 mm)

Material: PVC, PET, PET-G

- 
- ⚠ CAUTION**
- Do not use cards that do not conform to the CR-80 standard. Such cards may not be printed properly.
  - Do not use the following cards:
    - Cards previously printed with this or any other card printer
    - Wet cards
    - Cards mixed with glass, metallic or other foreign objects
    - Embossed cards
    - Cards coated with oil or other foreign matter
    - Cracked, chipped, bent or otherwise damaged cards
    - Transparent cards
    - Abnormally shaped cards

### ■ Cleaning Card

Please contact your reseller for cleaning cards.

### ■ Cleaning Tape

Please replace Cleaning Tape at the same time as Transfer Film. Cleaning Tape is included with Transfer Film.

- 
- ⚠ CAUTION**
- Do not use Cleaning Tape/Cleaning Cards other than those listed above. Doing so may cause a malfunction.

### ■ Consumables

Thermal Heads and Cleaning Rollers that have exceeded the following service lives (usage period, printed sheets) require replacement.

Product name	Service life
Thermal Head	Earlier of 1 year or 20,000 images
Cleaning Roller	Earlier of 1 year or 40,000 images

The service life depends on the usage environment.  
Please contact your reseller for consumables.

## Updating the Printer's Software

Please contact your reseller for upgrades to printer firmware and drivers.

# Menu Route Map (User Mode)

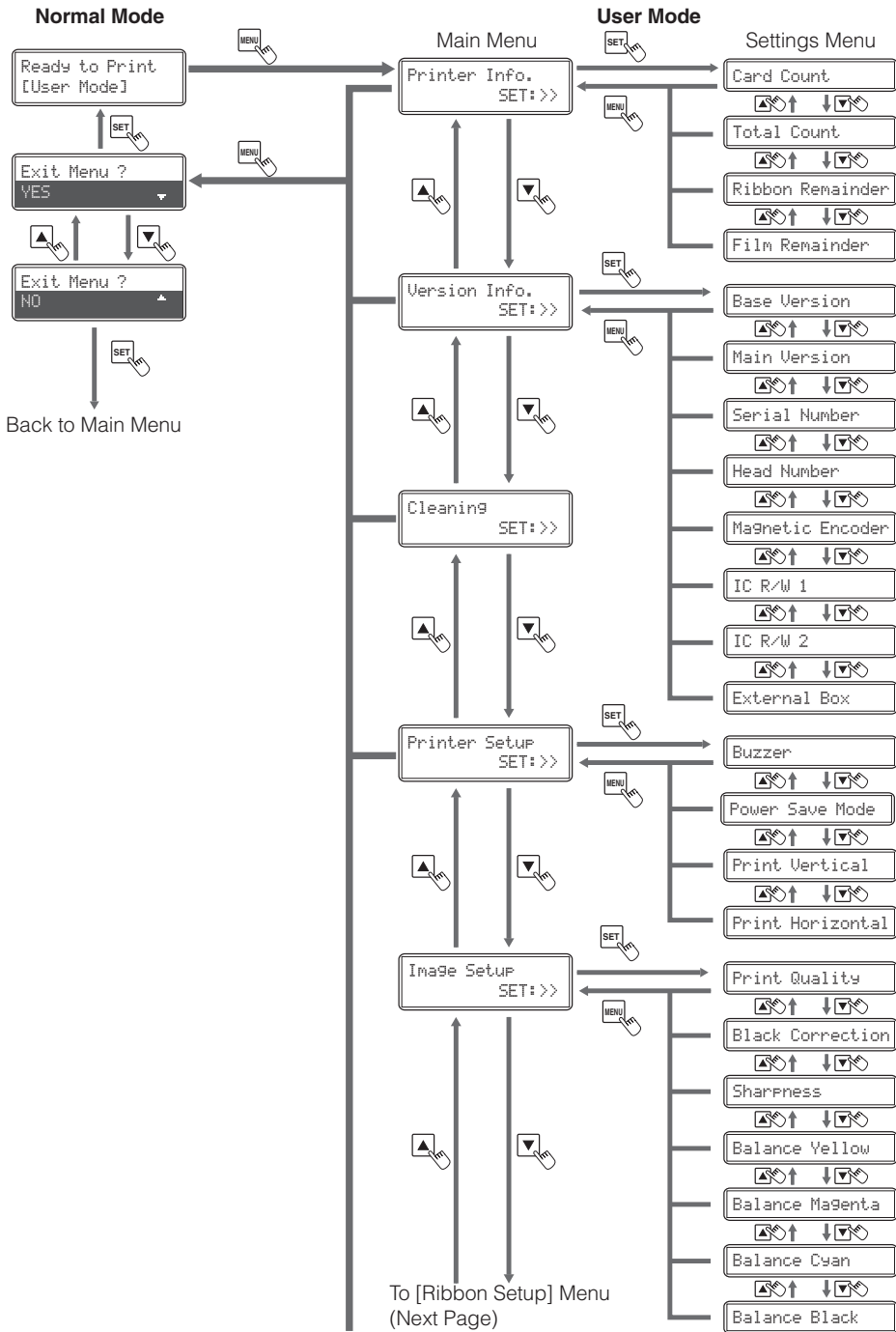



**User Mode**

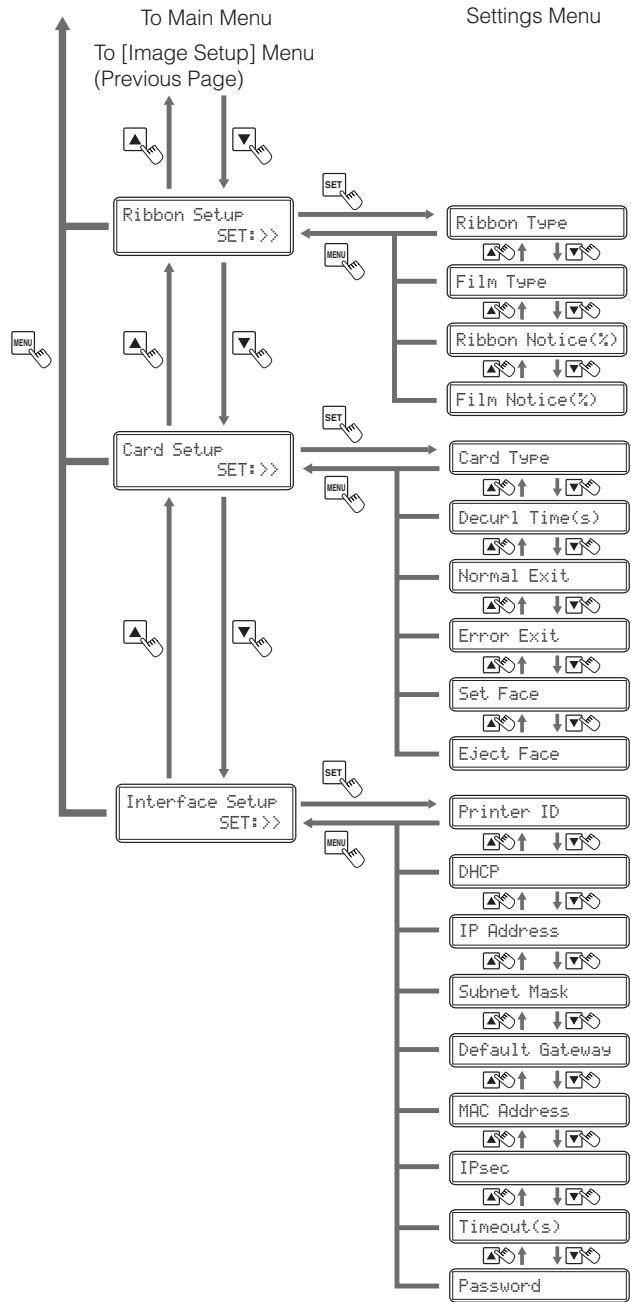

## Main Specifications

	PR-C201
Function	Double-sided printing (full color)
Print system	Indirect transfer system
Print media	Material: PVC, PET, PET-G Thickness: 0.76-1.00 mm Size: according to CR-80 standards
Print quality	600 dpi
Print tones	Input tones: RGB, 256 tones/color, K2 tones Output tones: YMC 256 tones/color, K2 tones + 256 tones
Print area	3.404" × 2.125" (86.5 mm × 54 mm)
Print time	160 cards/hour using 4 colors single side printing
Ink ribbon	R-YMCK Ribbon (Overcoating Colors - 4 colors) R-YMCKK Ribbon (Front: Overcoating Colors/Reverse: Monochromatic - 5 colors)
Transfer Film	R-InTM1 (film)
Card feeding system	Automatic feed from the Card Case (250 card auto feed) Manual feed
Interface	USB2.0 Ethernet 100BASE-TX, IEEE802.3u (Operation guaranteed) USB2.0 × 1 (Port for extended users) RS-232C × 2 (Port for extended users)
Supported OS	Windows XP (32 bit), Windows Vista (32 bit), Windows 7 (32/64 bit), Windows Server 2008 R2 (64 bit)
Power source	AC90/120, 220/240 V, 50/60 Hz
Power consumption	Less than 300 W
Operating noise	While operating: less than 53 dB While waiting: less than 45 dB
Dimensions	17.1" (H) × 13.4" (W) × 11.7" (D) (435 mm x 340 mm x 297 mm)
Weight	42.9 lb (19.5 kg)
Operating environment	Temperature: 50 to 95°F/10 to 35°C Humidity: 20 to 80% RH (without condensation)

## Opening the Printer Driver Settings Screen

You can change settings or confirm the status of the printer from the printer driver's setting screen.

### ■ Opening the Setting Screen (From the Start Menu)

**If you are using Windows Server 2008 R2, open the printer driver's setting screen as follows.**

[Start] → [Control Panel] → [View devices and printers] → [NISCA PR-C201] → [Printing preferences]

**If you are using Windows 7, open the printer driver's setting screen as follows.**

[Start] → [Control Panel] → [View devices and printers] → [NISCA PR-C201] → [Printing preferences]

**If you are using Windows Vista, open the printer driver's setting screen as follows.**

[Start] → [Control Panel] → [Hardware and Sound] → [Printers] → [NISCA PR-C201] → [Select printing preferences]

**If you are using Windows XP, open the printer driver's setting screen as follows.**

[Start] → [Control Panel] → [Printers and Other Hardware] → [Printers and Faxes] [NISCA PR-C201] → [File] menu → [Printing Preferences]

### ■ Opening the Setting Screen (From the Application)

**If you want to open the printer driver's setting screen from each application, follow the procedure below.**

[File] → [Print] → Select [NISCA PR-C201] as a printer name → [Preferences] (or [Properties])

### ■ Changing the Settings or Confirming the Status from the Setting Screen

**Follow the procedure below to change the settings or confirm the status after opening the setting screen.**

[Maintenance] tab → [Operation Panel] icon



**REF**

- For more information about how to change the settings of the printer driver, refer to the driver help files.
- If using a network, the printer driver name will be "NISCA PR-C201 Network".

